



FORTHING



# TAIKON 5 EV USER MANUAL

English



Dear users,

Congratulations on owning a Taikon 5. Thank you for your trust in the Forthing brand. This manual introduces the information on safe driving, equipment operation and vehicle maintenance of Taikon 5. The information will help you use the vehicle correctly so that you can truly feel the driving pleasure brought by Forthing car.

The table of contents and illustrations of vehicle in this manual can facilitate you to understand your car quickly. The following chapters provide a detailed introduction to the use methods of various vehicle facilities. Before using the vehicle, please carefully read the documents delivered with the vehicle. The information provided in these documents is very important for guaranteeing the driving and property safety, please strictly observe and properly keep these documents.

When reading this manual, you will find signs such as "Caution", "Warning" and corresponding instructions. These instructions are contributive to guaranteeing the personal, vehicle and property safety, please strictly observe.

Graphs and texts in this manual are only for the purpose of transmitting use information of main functions and facilities of the vehicle, instead of serving as the basis for the product acceptance. In case of any discrepancies from the actual vehicle, the actual vehicle shall prevail.

Copyright notice: Content and technical specifications in this manual were effective at the time of publication. However, Dongfeng Liuzhou Motor Co., Ltd. reserves the right to change technical specifications and design at any time without prior notice.

Technical update instructions: Electronic technology products upgrade rapidly. Please update in time to guarantee user experience.

Dongfeng Liuzhou Motor Co., Ltd.  
June 2026

All rights reserved. This manual may not be copied or reproduced without prior written permission of Dongfeng Liuzhou Motor Co., Ltd.

Note: The cover and pictures of this manual are provided for reference only, and the actual vehicle shall prevail.

01

02

03

04

05

06

07

08

09

10

11

## Configuration description

### \* Asterisk

Asterisk “\*” following the title or name indicates that described device or function is only equipped in certain models, and may not necessarily be equipped in your vehicle.

### Safety instructions

Safety label plates - Attached to the vehicle.

Safety prompt information - identified by hazard warning symbols and words such as "Danger", "Warning" or "Caution". The meanings of these words are as follows:

#### Danger

Used to indicate the danger that may cause serious personal injury or death.

#### Warning

Used to indicate the danger that may cause personal injury or other damage.

#### Caution

Used to indicate the danger that may cause minor personal injury or vehicle damage.

## Data safety instructions

According to laws, administrative regulations and other provisions, in order to provide you with more convenient and fast service, Dongfeng Liuzhou Motor Co., Ltd. may collect personal information and vehicle data such as the VIN, drive motor number, and driving behavior when you use the vehicle or when we provide services for you. We will take measures that meet legal requirements and national or industrial technical standards to protect the security of your personal information and vehicle data.

In case of transfer, scrapping or second-hand car transaction, it is recommended that you clean up your sensitive personal data in time. You can also contact an authorized service station of Dongfeng Forthing for data cleaning channels and methods.

**Table of Contents**



Vehicle Illustration Index .....5	01
Charging System .....10	02
Safety and protection .....22	03
Instrument cluster .....42	04
Operation of Basic Functions.....51	05
IVI system .....85	06
Convenience device .....116	07
Comfortable driving .....122	08
Service and Maintenance.....175	09
Emergency self-handling .....188	10
Vehicle specifications.....206	11



**Vehicle illustration .....6**

Front of vehicle ..... 6

Rear of vehicle..... 7

**Interior.....8**

Interior roof ..... 8

Dashboard ..... 8

Auxiliary dashboard..... 9

## Vehicle illustration

### Front of vehicle

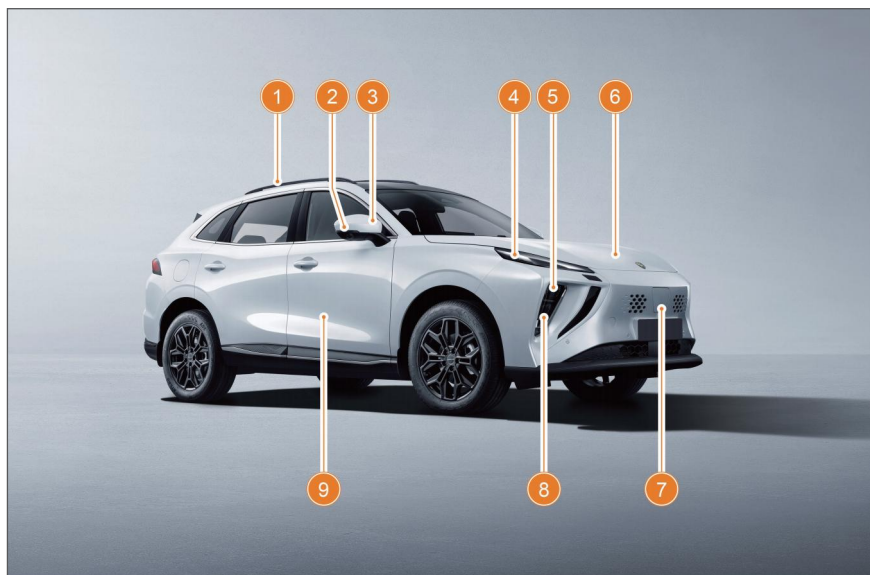

1. Luggage rack\*

2. Side turn signal

3. Exterior rearview mirror

4. Front turn signal/daytime running light/position light

5. Low beam

6. Hood

7. Charging port cap

8. High beam

9. Doors

## Rear of vehicle

01



1. Rear turn signal/position light/brake light

2. High-mounted brake light

3. Trunk lid

4. Rear wiper

5. Retro-reflector

6. Rear fog light

7. License plate light

8. Reversing light

## Interior

### Interior roof

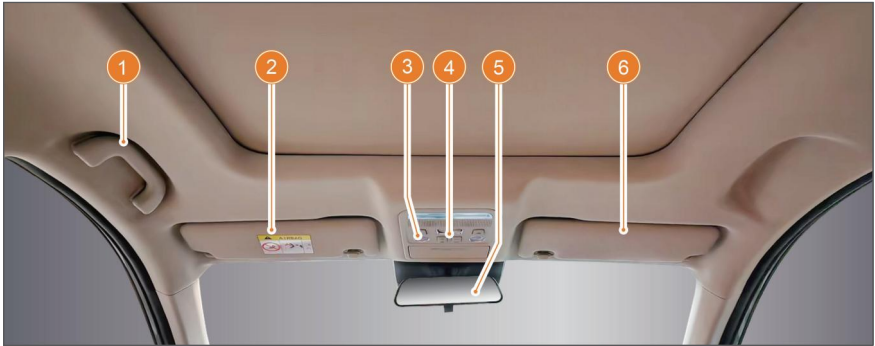

1. Top handle

2. Left sun visor

3. Front interior light

4. Sunroof/Sunshade control button\*

5. Interior rearview mirror

6. Right sun visor

### Dashboard

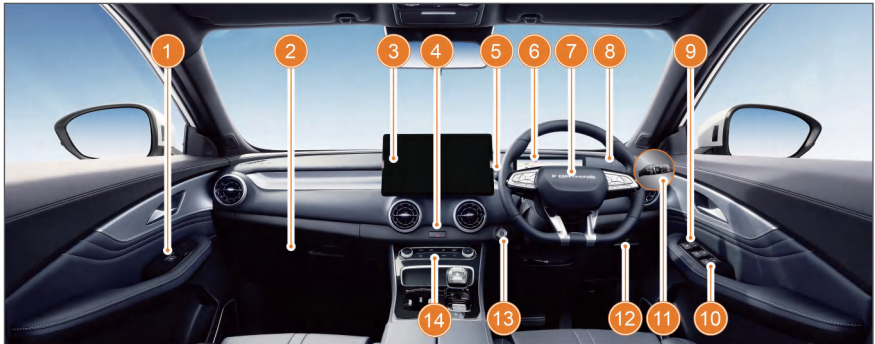

1. Power window control switch of front passenger seat

2. Glove box

3. Multimedia display

4. Hazard warning light switch

5. Light control handle

6. Instrument cluster

7. Steering wheel

8. Mobile phone bracket interface

9. Central control buttons

10. Driver side power window regulator switch

11. Wiper control handle

12. Dashboard switch set

13. Start switch

14. A/C control panel

## Auxiliary dashboard

01

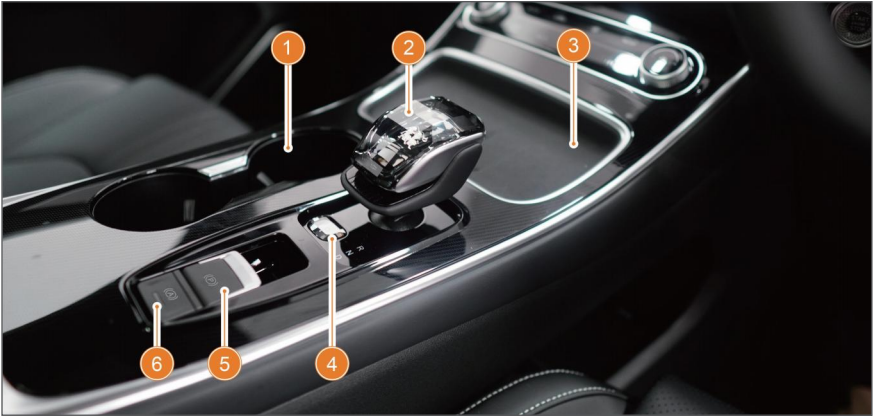

1. Front passenger cup holder

2. Gearshift lever

3. Wireless charging\*

4. P gear button

5. Parking brake (EPB) switch

6. AUTO HOLD switch

## Charging System

### Precautions for charging 11

#### Charging port..... 13

- Opening and closing of charging port cap ..... 13

#### AC charging with portable charging plug ..... 14

- Operation steps ..... 14
- Charging time ..... 14

#### Charging with AC charging pile ..... 15

- Operation steps ..... 15
- Charging time ..... 15
- Emergency unlocking of AC charging plug ..... 15

#### 220V AC exterior discharging ..... 16

- Operation steps ..... 16
- Stop 220V AC exterior discharging ..... 16

#### DC charging pile charging ..... 17

- Operation steps ..... 17
- Charging time ..... 17

#### Power battery in-transit heating\* ..... 18

#### Common troubleshooting for charging ..... 19

#### Charging limit setting.... 19

### Precautions for charging

1. After charging, please ensure that the charging port cover is closed. Closing only the charging port cap without closing the charging port cover may allow water or foreign objects to enter the charging port, resulting in charge failure.

2. When the power battery is being charged, do not attempt to jump-start from the 12V low-voltage battery. This may damage the vehicle or charging equipment or result in personal injury. For detailed procedures, refer to "Jump Start" in the "Emergency self-handling" section.

3. Do not insert any object other than the charging/discharging plug into the charging port; otherwise, the charging port may be damaged.

4. Before connecting to a portable charging plug or AC charging pile, make sure that a dedicated charging power supply is used. It is recommended to use a dedicated AC line and power socket that meet local regulations and standards to connect the portable charging plug for charging.

5. Charging temperature range of power battery:  $-20^{\circ}\text{C}\sim 55^{\circ}\text{C}$ .

6. The temperature of the power battery is not equal to the ambient temperature. The temperature of the power battery will be basically consistent with the ambient temperature after being placed in the environment for about 12~18 hours when it is stationary.

7. The electrolyte of the power battery is a chemical material. Due to the

composition and proportion of chemical materials, charging the power battery at low temperatures easily leads to its service life attenuation, which poses potential safety hazards. Charging it at a temperature above  $0^{\circ}\text{C}$  as far as possible is recommended.

8. During charging, if the power battery temperature is low, the vehicle will activate the battery heating system to heat the power battery. During charging in the heating process, the vehicle will prioritize using the external power source to heat the power battery. Therefore, it is normal that the SOC of the power battery remains unchanged, rises slowly, or even dips before climbing.

9. When the ambient temperature is below  $0^{\circ}\text{C}$ , please charge immediately after the vehicle stops running as far as possible.

10. During charging, if the temperature of the power battery is high, the vehicle will activate the cooling system to cool the power battery. During charging in the cooling process, the vehicle will prioritize using the external power source to cool the power battery. Therefore, it is normal that the SOC of the power battery remains unchanged or rises slowly. When the external power supply is underpowered, the vehicle will also use the power battery and the external power supply to cool the power battery at the same time. It is normal that the SOC of the power battery decreases first and then increases.

11. Do not open or close the engine

## Charging System

hood when the charging port cap is open.

12. When the power battery temperature is low, full-power charging may not be possible at the initial charging stage. As the power battery temperature increases, the charging power will also increase.

13. When the weather is cold, try to choose warm locations such as basements for charging, as this can shorten the charging time.

14. If the power supply resumes after a short-time outage of the external power grid, the charging equipment will re-start charging automatically (the time for restarting charging may be extended). In case of multiple power failures, please stop charging and check whether the power supply is normal.

15. During vehicle charging, if the power grid fluctuates greatly, the charging power will fluctuate, and even charging may be suspended.

16. After the power battery is fully charged, the system will automatically stop charging.

17. When using a portable household AC charging plug, pull out the AC charging plug and then disconnect the power plug when stopping charging.



### Caution

- To prevent damage to the vehicle charging equipment, please observe the following requirements:
  - Do not close the charging port cap when the charging port cover is open.
  - Do not strike any charging equipment.



### Caution

- Do not drag the charging plug or charging cable.
- Do not store or use charging equipment at temperatures above 50 °C.
- Do not place the charging equipment near a heater or other heat sources.
- Do not insert an AC charging plug and a DC charging plug for charging at the same time.



### Warning

- If you have used medical equipment (e.g. implanted cardiac pacemaker or cardioverter defibrillator), before charging, the equipment manufacturer must check whether it will affect the medical equipment before use.
- When the power battery is charged, incorrect operation may cause safety accidents such as short circuit, electric shock and fire, and even endanger personal safety in severe cases.
- Do not touch metal objects of the charging port, charging plug or power plug.
- Do not use extension cables or electrical plug adapters. Do not disassemble or modify the charging port, portable charging plug and AC charging pile.
- Do not use charging plugs, AC charging piles or DC charging piles that do not meet the requirements of local laws and regulations for charging.



## Warning

- Before starting the vehicle, make sure that the charging plug has been removed from the charging port.
- During charging, the cooling fan may start at any time. Please ensure that hands, hair, jewelry, or clothing do not come into contact with the cooling fan.
- Please do not charge the vehicle in the open air in thunderstorm weather. Lightning shock may cause damage to the charging equipment, and soaking in rainstorms may also cause damage to the power battery due to short circuit.
- If you detect any pungent odor or see smoke coming out of the vehicle, please stop charging or discharging immediately and keep away from the vehicle as soon as possible.
- Before charging or discharging, please make sure that there is no water or foreign object in the charging port, charging plug, or power plug, and that the charging equipment is not damaged or corroded. If any of the above conditions is found, do not charge or discharge the vehicle.
- The charging equipment must be well grounded. If the charging equipment fails or is damaged, the ground wire can reduce the risk of electric shock.

## Charging port

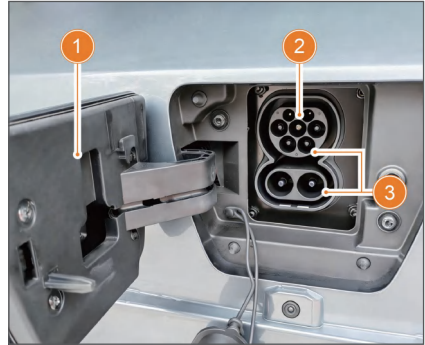

1. Charging port cap
2. AC charging port
3. DC charging port

The charging port is located below the vehicle front bumper logo. When you need to charge, please open the charging port cap and the charging port cover, and connect the AC or DC charging connection equipment with its corresponding charging port for charging.

## Opening and closing of charging port cap

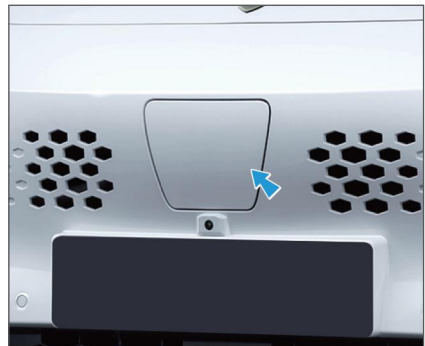

### Normal opening

When the door is unlocked, press the right side of the charging port cap to

# Charging System

open it, pull out the charging port cover, and connect the charging connection equipment with the charging port.

## Normal shutdown

After charging is completed, pull out the charging plug, cover the charging port cover and the charging port cap in turn, and press the right side of the charging port cap to close the charging port cap.

## AC charging port lock

If the vehicle is being charged and in a non-READY state, the AC charging port is locked. Press the unlock button on the smart key or the central control unlock button twice. After the AC charging port is unlocked, the charging plug can be pulled out normally.

## DC charging port lock

When charging stops, if the DC charging port is locked, unlock it according to the unlocking steps of the charging pile, and then pull out the charging plug normally.

## AC charging with portable charging plug

The portable charging plug is not equipped with the vehicle and needs to be provided by the owner. Please use a portable charging plug that complies with local regulations and standards. The following content only introduces the use of the portable charging plug. The specific configuration shall be subject to the actual vehicle.

### Operation steps

1. After the vehicle stops, press the P gear button and confirm that the P gear

indicator of the instrument cluster lights up.

2. Open the charging port cap and AC charging port cover.

3. Take out the portable charging plug.

4. Remove the shield from the portable charging plug interface.

5. Check whether the three-pin socket of household power supply is reliably grounded.

6. Plug the power plug of the portable charging plug into a household power socket.

7. Connect the portable charging plug to the AC charging port on the vehicle.

8. During charging, the charging plug will be locked automatically. After charging is completed, if the charging plug needs to be pulled out, press the unlock button on the smart key or carry the smart key and pull the driver's door handle to unlock the AC charging port. At this time, the charging plug can be pulled out normally.

9. Pull out the portable charging plug from the household power socket, install the shield back onto the portable charging plug, wind the portable charging plug and put it back to the designated position.

10. Close the AC charging port cover and charging port cap, press the right side of the charging port cap, and close the charging port cap.

### Charging time

Due to the comprehensive influence of ambient temperature, power supply environment and other factors, the actual charging time shall be subject to the remaining charging time on the

instrument cluster display.



When charging with a household power supply, ensure that the selected socket and patch cords can handle a current no less than the rated current specified on the nameplate of the AC charging socket. Ensure that the three-pin socket of the household power supply is reliably grounded; otherwise, there is a danger of electric shock.

## Charging with AC charging pile

The AC charging pile is not equipped with the vehicle and needs to be provided by the vehicle owner. Please use an AC charging pile that meets local regulations and standards. For specific usage methods, please refer to the instructions for use of the purchased charging pile.

### Operation steps

1. After the vehicle stops, press the P gear button and confirm that the P gear indicator of the instrument cluster lights up.
2. Open the charging port cap and AC charging port cover.
3. Remove the charging plug from the AC charging pile.
4. Connect the charging plug to the AC charging port on the vehicle.
5. Start the charging function according to the operation steps and methods indicated on the AC charging pile.
6. During charging, the charging plug will

be locked automatically. After charging is completed, if the charging plug needs to be pulled out, press the unlock button on the smart key or carry the smart key and pull the driver's door handle to unlock the AC charging port. At this time, the charging plug can be pulled out normally.

7. Turn off the power supply of the AC charging pile, and put the charging plug on the AC charging pile back to the designated position.

8. Close the AC charging port cover and charging port cap, press the right side of the charging port cap, and close the charging port cap.

### Charging time

Due to the comprehensive influence of ambient temperature, charging pile power, power supply environment and other factors, the actual charging time shall be subject to the remaining charging time on the instrument cluster display.

### Emergency unlocking of AC charging plug



If the AC charging plug cannot be pulled out after pressing the unlock button on the smart key or holding the

# Charging System

unlock area inside the driver's door handle with the smart key to unlock the vehicle door, pull the emergency unlocking pull ring located above the charging port outward to unlock the AC charging plug in an emergency.

## 220V AC exterior discharging

The AC discharging plug is not equipped with the vehicle and needs to be provided by the owner. Please use a discharging gun that meets local regulations and standards; otherwise, it may cause vehicle fault or safety accidents.

### Operation steps

1. After the vehicle stops, press the P gear button and confirm that the P gear indicator of the instrument cluster lights up.
2. Please confirm that the SOC displayed on the instrument cluster is greater than 30%, and the discharging function cannot be used when the SOC is less than 30%.
3. Take out the discharging plug and remove its shield.
4. Open the charging port cap and the AC charging port cover, and connect the discharging plug to the AC charging port on the vehicle.
5. Press the switch (if any) on the power strip to discharge.

### Stop 220V AC exterior discharging

To stop 220V AC discharging, proceed as follows:

1. Turn off the electrical equipment and press the power strip switch (if any) to disconnect the power supply.

2. After the discharging is completed, if the discharging plug needs to be pulled out, press the unlock button on the smart key or carry the smart key and pull the driver's door handle to unlock the AC charging port. Press the release button on the discharging plug and unplug the discharging plug.

3. Install the discharging plug shield, and then put it back in the designated position and fix it.

4. Close the AC charging port cover and charging port cap, press the right side of the charging port cap, and close the charging port cap.



#### Caution

- When the SOC of power battery is less than 30%, do not use the AC discharging function.
- The charging port for 220V AC discharging is the same as that for AC charging, so the locking and unlocking operations of the discharging plug are also the same as those of the AC charging plug.
- When using the AC discharging function, it is recommended to power off the vehicle. When in the ON gear, the vehicle will increase the power consumption of the power battery. It is necessary to pay attention to the remaining SOC of the power battery in real time.



#### Warning

- Do not impact or drag the discharging equipment, and do not pull out the discharging cable.



## Warning

- Do not store or use the discharging equipment in a place with water or near heat sources.
- Please use the specified discharging equipment. Otherwise, safety accidents may be caused.
- Do not use the discharging equipment when the insulation layer or power strip is damaged.
- The 220V AC exterior discharging standard of the vehicle is:  $220V \pm 5\%$ ,  $50Hz \pm 0.5Hz$ . Before use, it is necessary to confirm whether the connected equipment is suitable. Our company will not be responsible for damage caused by incompatible equipment.
- When using the AC discharging function, the total power of electrical appliances shall not exceed 3.3 kW; otherwise, it may cause safety accidents.

DC charging port.

4. DC charging shall be carried out according to the operation instructions of DC charging pile.

5. After the vehicle's charging is complete, the automatic control system of the DC charging pile can automatically terminate the charging session. Alternatively, you can manually stop the charging according to the operating instructions of the DC charging pile.

6. After charging, pull out the charging plug and put it back to its original position.

7. Put back the DC charging port cover and charging port cap, press the right side of the charging port cap, and close the charging port cap.

8. During DC charging, if the DC charging pile detects an abnormality and stops charging, "Charging pile fault" will be displayed on the instrument cluster. In this case, it is recommended to change another charging pile for charging. If "Charging pile fault" is still displayed on the instrument cluster after the change, it is recommended to contact a Forthing service station for inspection of the vehicle.

## DC charging pile charging

The DC charging pile is not equipped with the vehicle and needs to be provided by the owner. Please use it in accordance with local regulations and standards. The following content only introduces the use of DC charging piles.

### Operation steps

1. After the vehicle stops, press the P gear button and confirm that the P gear indicator of the instrument cluster lights up.
2. Open the charging port cap and DC charging port cover.
3. Insert the DC charging plug into the

### Charging time

Due to the comprehensive influence of ambient temperature, charging pile power, power supply environment and other factors, the actual charging time shall be subject to the remaining charging time on the instrument cluster display.



### Caution

- It is recommended to use DC charging piles that meet local regulations and standards for DC charging; otherwise, it may cause fault or fire, resulting in casualties.
- Before DC charging, please read the operating instructions on the DC charging pile carefully and use it in strict accordance with the operating instructions.
- It is strictly prohibited to pull out or insert the DC charging plug at will during charging. If you need to stop charging, please operate in strict accordance with the operating instructions on the DC charging pile.
- After charging stops, the DC charging pile will still run for a while. Pull out the DC charging plug after the charging pile stops running.
- According to the power battery properties, it is recommended to fully charge the power battery at least once within one week after frequent use of the vehicle. If the vehicle is not fully charged after long-distance driving, there may be phenomena such as rapid increase in SOC at the end of charging, long duration at the end of charging, or rapid decrease in SOC at the end of discharging. The above situations are all normal phenomena and have no damage to the power battery.

## Power battery in-transit heating\*

When driving in cold weather to find a fast charging pile, tap [Heating while driving] on the energy center interface of the multimedia display about 1 hour in advance to turn on the power battery in-transit heating function and heat the power battery to the most suitable temperature range before charging, thereby shortening the fast charging time.

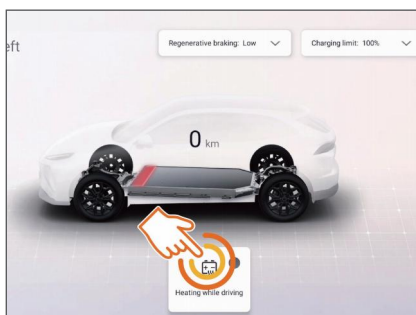

It is recommended to turn on the power battery in-transit heating function when the ambient temperature is less than 10°C, the remaining capacity of the power battery of the instrument cluster is greater than 25% and there is a need to shorten the fast charging time.



### Caution

- The power battery in-transit heating function cannot be activated when the vehicle is not started, the ambient temperature is higher than 19°C or the power battery SOC of the instrument cluster is less than 20%.
- The in-transit heating function of the power battery will be automatically turned off 2 hours after it is turned on.

## Charging limit setting

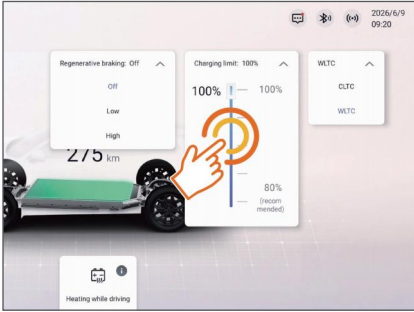

In the Energy Center interface, tap [Charging limit] to adjust the charging limit range between 80% and 100%.

02

## Common troubleshooting for charging

Symptom	Possible cause	Solution
Unable to charge or unable to discharge at 220V	The vehicle is not in P gear	Shift to the P position before charging.
	The charging equipment is not connected correctly	Check whether the charging equipment is connected correctly and charge in the correct way.
	Power battery temperature too high or too low	Check the power battery temperature to ensure that it is within the allowable range. If it's too hot or too cold, cooling or heating is required before charging.
	12V low-voltage battery voltage is too low	If the voltage of the 12V low-voltage battery is lower than 9 V, charge the 12V low-voltage battery or jump start the vehicle before charging. Please refer to "Jump Start" in the chapter "Emergency self-handling".
	Vehicle fault	If the vehicle is faulty, please first confirm whether the warning light on the instrument cluster illuminates or indicates a charging fault. If a warning or charging fault is displayed, stop charging and contact a Forthing service station.

## Charging System

Symptom	Possible cause	Solution
Unable to charge	The power battery has been charged to the set charge level	If the battery has been charged to the set level, charging cannot continue. If you need to continue charging, please reset it.
	The charging power supply is not grounded	Check whether there is any relevant fault display. If the relevant fault is displayed, stop charging and contact the Forthing service station.
	The charging power supply is not supplying power normally	
	Power supply consistent with the local power grid is not used	Check whether there is any relevant fault display. If the relevant fault is displayed, stop charging and contact the Forthing service station.
Unable to charge	The power battery is fully charged	Unplug the charging plug, start the vehicle, and check whether the SOC indicator of the vehicle shows 100%. If the display shows 100%, the power battery is fully charged, and charging stops.
	Quick charging pile fault	Confirm whether the instrument cluster prompts a charging pile fault. If a relevant message is displayed, it indicates that the fault is caused by abnormal quick charging pile. It is recommended to replace the charging pile for charging. If the fault message is still displayed after the charging pile is replaced, it is recommended to contact a Forthing service station for inspection.
	Charging facilities do not meet local regulations and standards	Use a portable charging plug or charging pile that meets local regulations and standards for charging.

Symptom	Possible cause	Solution
Charging stops halfway	The power supply is disconnected	Check whether the power supply is disconnected. If so, please connect the power supply and re-execute the charging steps for charging.
	The charging plug is disconnected	Check whether the charging plug is disconnected. If so, please connect it and re-execute the charging steps for charging.
	Power battery temperature too high	Check the power battery temperature to ensure that it is within the allowable range. In case of overheating, please cool it for a while before recharging.
	The pause or stop button in the charging equipment has been pressed	Check whether the pause button or stop button in the charging equipment is pressed. If pressed, the charging device needs to be activated to restart charging.
	Vehicle fault	If the vehicle is faulty, please first confirm whether the warning light on the instrument cluster illuminates or indicates a charging fault. If a warning or charging fault is displayed, stop charging and contact a Forthing service station.
Discharging stops halfway	The power supply is disconnected	Check whether the power supply is disconnected. If so, please connect the power supply and re-execute the discharging steps for discharging.
	Discharging plug is disconnected	Check whether the discharging plug has been disconnected. If so, please connect it and re-execute the discharging steps for discharging.
	Power battery temperature too high	Check the power battery temperature to ensure that it is within the allowable range. In case of overheating, please cool it for a while before discharging.
	Vehicle fault	If the vehicle is faulty, please first confirm whether the warning light on the instrument cluster illuminates or indicates a charging fault. If a warning or charging fault is displayed, stop charging and contact a Forthing service station.

## **Seat belt..... 23**

- Introduction to seat belt .....23
- Seat belt retractor .....23
- Seat belt pretensioner .....23
- Unfastened seat belt alarm23
- Precautions for using seat belt .....24
- Fastening and releasing the seat belt .....25
- Seat belt shoulder belt height adjustment .....25
- Force-limiting Function of Seat Belt .....25
- Work related to seat belt....25

## **Airbag ..... 25**

- Introduction to Airbag.....25
- Function and Description of Airbag .....25
- Airbag usage precautions..26
- Position and deployment of airbags .....27
- Deployment condition of front seat frontal airbag .....28
- Deployment conditions of front side airbag and side curtain airbag\* .....28
- Circumstances where the front seat frontal airbag may not deploy .....28

- Types of collision without deployment of front side airbags and side curtain airbag \* .....29
- Airbag indicator.....30

## **Event Data Recorder (EDR) .....30**

## **Children protection measures ..... 35**

- Riding Instructions for Children .....35
- Protective measures for infants .....35
- Protective measures for young children .....36
- Protective measures for older children .....36
- Applicable information of child restraint system .....36
- Installation of rear-facing child restraint system .....39
- Installation of forward-facing child restraint system .....39
- Installation of Auxiliary Seat Cushion .....39
- Child Safety Seat .....40
- Installation of child restraint system .....40

## Seat belt

### Introduction to seat belt

In accidents caused by emergency braking, sudden turning and collision, the seat belts will restrain the driver and passengers on the seats to prevent their bodies from moving forward, thus protecting them from secondary impacts. Correct use of seat belts can reduce injuries to passengers in the vehicle.



#### Caution

- Before driving, make sure that all passengers in the vehicle have fastened their seat belts correctly and always use them when the vehicle is in motion. Seat belts can protect the driver and passengers to the greatest extent in an accident.
- The seat belts in the vehicle are mainly designed based on the body shape of adults and not suitable for children. Please select a suitable child restraint system according to your child's age and body shape.
- If the seat belt or retractor is damaged or abnormal, please contact an authorised Forthing service station immediately for confirmation and handling. Do not use the corresponding seat before handling.

### Seat belt retractor

Each seat belt is equipped with a seat belt retractor. During normal driving, the retractor keeps a certain tension on the seat belt so that the driver and passengers can still move freely on the seat. In case of an emergency, the retractor will automatically tighten to

restrain the driver and the passenger on the seats to avoid injury. In case of abnormal locking function of the retractor, please contact an authorised Forthing service station.

### Seat belt pretensioner

When the vehicle suffers from some serious frontal or side collisions, the seat belt pretensioner will automatically tighten to quickly protect the driver and passengers.



#### Caution

The pretensioner may not be activated in the event of a minor frontal, side, rear collision or rollover.



#### Warning

Users are not allowed to repair, adjust, remove and install the seat belt and retractor by themselves. If maintenance or replacement is required, please contact an authorised Forthing service station.

### Unfastened seat belt alarm

The vehicle is equipped with a seat belt unfastened warning. When the vehicle is started but not moving, if it is detected that the driver and passengers are not wearing seat belts, the front/rear seat belt unfastened warning light of the instrument cluster will light up. When the vehicle detects that the driver and passengers are not wearing seat belts during driving, the front/rear seat belt unfastened warning light of the instrument cluster will light up. The buzzer will continue to alarm until the driver and passengers fasten their seat belts.

## Safety and Protection

### Precautions for using seat belt

Please read the following contents carefully and strictly observe them, which will help you master the correct operation method.

#### Correct use of the seat belts

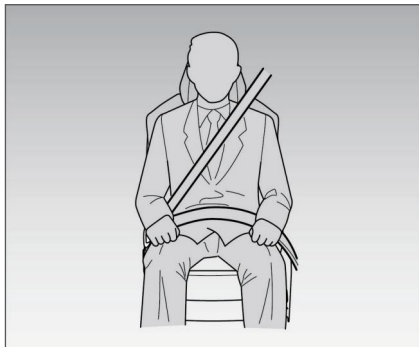

1. Pull out the shoulder belt diagonally across the entire shoulder without contacting the neck or falling from the shoulder.
2. Wear the lap portion of the seat belt as low as possible across the hips.
3. Adjust the position of the seat backrest to set it to a relatively comfortable position.



#### Caution

- Always wear a seat belt properly.
- Do not cross the seat belt across the lower abdomen. Otherwise, the seat belt will strongly press the lower abdomen in case of an accident.
- Do not place the shoulder seat belt under your arm.
- Tighten the seat belt as much as possible. A loose seat belt will slide from a hard part of your body to a soft part (e.g., abdomen), increasing the risk of injury.



#### Warning

- Incorrect wearing of seat belt may cause injury in case of accident or emergency braking or sudden driving manoeuvres.
- The shoulder belt must go over the middle of the shoulder without passing under the arm or across the neck.
- The waist belt must pass the front of the hip without passing over the abdomen. The seat belt must be flat and close to the hip. If necessary, slightly tighten the seat belt.
- Pregnant women should also, like other passengers, place the seat belt across the hip as low as possible, with the shoulder seat belt fully stretched obliquely along the shoulder, and avoid the seat belt touching the raised abdomen. If the seat belt is not fastened correctly, the pregnant woman and the foetus may be injured in case of emergency braking or collision.
- Do not tilt the seat backrest excessively when the vehicle is running. The seat belt can provide effective protection only when the backrest angle is about 25°; otherwise, it may cause serious injuries or death in case of an accident.
- Do not pull the seat belt away from your body with your hands.
- Do not twist the seat belt when wearing.
- Seat belts shall not rest against hard or fragile objects, such as glasses, ballpoint pens or keys. Do not alter the direction of the seat belt by means of belt clamps, retaining rings or similar objects.

## Fastening and releasing the seat belt



**Fastening:** Pull out the seat belt from the retractor, cross the seat belt across your chest and hips, and insert the latch plate into the buckle until you hear a "click", which indicates that the seat belt is locked.

**Unfastening:** Press the red release button at the buckle socket and pull out the latch plate.

## Seat belt shoulder belt height adjustment



1. Press the upper part of the seat belt shoulder belt height adjuster, move it up and down to the desired position until a "click" sound is heard.
2. Try to move the adjuster down without pressing to make sure it is locked in

place.

## Force-limiting Function of Seat Belt

Seat belt force limiting function. When the vehicle is hit by some serious frontal or side collisions, the force limiting function will limit the force acting on the seat belt to a certain extent to alleviate the impact force on the occupant's chest.

## Work related to seat belt

1. Regularly check the status of all seat belts.
2. Keep the seat belt clean.
3. Make sure that the seat belt, latch plate, and seat belt buckle socket do not come into contact with liquids or foreign object.

## Airbag

### Introduction to Airbag

The Supplemental Restraint System (SRS) is an auxiliary restraint device of the seat belt. When the degree of front or side collision meets the deployment requirements of the airbag, the airbag will be inflated and deployed to reduce the impact injuries to the head and chest of the driver and passengers.

Airbag is only designed to provide additional protection. Airbags cannot replace seat belts. Seat belts must always be fastened.

### Function and Description of Airbag

In case of a frontal or lateral collision accident, the airbag can restrain the passengers from moving towards the collision direction, so as to protect them. Key factors affecting airbag deployment

## Safety and Protection

include the type of accident, collision angle, vehicle speed and characteristics of objects that collide with the vehicle. Therefore, the airbag may not be triggered in every collision accident.



### Warning

- While the vehicle is in motion, all occupants must wear seat belts correctly and maintain a proper sitting posture.
- The SRS can be triggered only once. Any airbag triggered in an accident must be replaced.
- Do not attempt to modify any component of the SRS.
- The airbag can only provide auxiliary protection. Do not rely solely on the airbag for protection.

### Airbag usage precautions



1. There are airbag warning signs on the inside and outside of the left sun visor. Do not use rear-facing child restraints on seats protected by frontal airbags (in the activated status), otherwise it may cause death or serious injury to children.

2. Do not place any object on the dashboard or paste it on the steering wheel trim cover or other positions,

because these objects may be ejected when the front seat frontal airbag deploys, resulting in casualties of the driver and passengers.

3. Do not hang clothes hangers or other hard objects on the side wall hooks. When the side curtain airbag deploys, these items may be ejected and cause casualties to passengers.

4. Do not carry items on the front passenger seat. In case of sudden braking or emergency driving, these objects may enter the expansion range of the front seat frontal airbag and be thrown away when the airbag is triggered, bringing life risk.

5. Do not hold objects in your hands or children and pets in your arms while the vehicle is in motion. Otherwise, the risk of injury will increase if the airbags are deployed.

6. The temperature is very high after the airbag is deployed. Do not touch any relevant components immediately.

7. When the airbag deploys, it will be accompanied by a loud noise, which may temporarily affect hearing.

8. If you experience difficulty breathing after airbag deployment, please open the door or window for ventilation, or leave the vehicle if it is safe to do so, and rinse any residue from your body as soon as possible to avoid skin irritation.

9. Do not use detergent containing solvent to clean the surfaces of the dashboard and airbag module. Otherwise, the surface of the airbag module will be changed, resulting in an increased risk of personal injury due to falling plastic parts when the airbag is triggered.

10.If the part where SRS is located is damaged or broken, please contact an authorized Forthing service station for replacement.

## Position and deployment of airbags

### Front seat frontal airbag

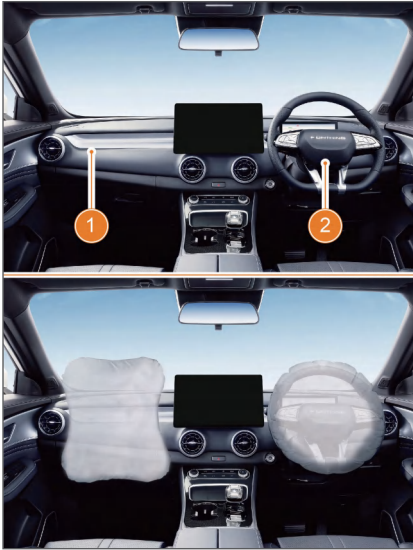

- 1.Front passenger frontal airbag.
- 2.Driver frontal airbag

The front seat frontal airbag helps to protect the head and chest of the driver and front passenger from the impact of interior components.

### Front side airbag\*



The front side airbags are installed in the backrests of both the driver seat and the front passenger seat; the backrests are marked with the sign "AIRBAG". In case of medium to heavy lateral collisions, the front side airbags will function simultaneously through inflation and seat belts to reduce the severity of personal injuries.

### Side curtain airbag\*



The side curtain airbags are mounted above the vehicle doors on the left and right sides, where the signs of "SRS AIRBAG" are marked. In case of moderate to severe side collisions, the side curtain airbags will deploy to protect the heads of the driver, front passenger and rear outer passengers from hitting the inner wall of the vehicle.



### Warning

As the front side airbags and side curtain airbag have considerable speed and force when deployed, do not place your head close to the deployment area of the side airbags and side curtain airbags when the vehicle is running; otherwise, you may be injured.

### Deployment condition of front seat frontal airbag

When the vehicle is subjected to a moderate to severe frontal collision or a near-frontal collision, when the system triggering conditions are met, the front airbag will deploy to buffer the speed of the driver and passengers' forward impact and prevent them from directly hitting the steering wheel and dashboard.

### Deployment conditions of front side airbag and side curtain airbag\*

When the vehicle has a moderate to severe side collision and reaches the designed action value, the front side airbags and side curtain airbag can be deployed.

### Circumstances where the front seat frontal airbag may not deploy



Stationary vehicles or collisions with easily deformable objects such as trees and telegraph poles.



The vehicle collides violently with low objects such as steps during driving.

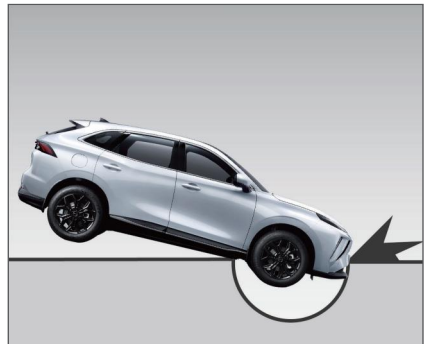

The vehicle suddenly falls into a deep pit

or ditch.



The vehicle hits the rear end of (runs under) a truck.

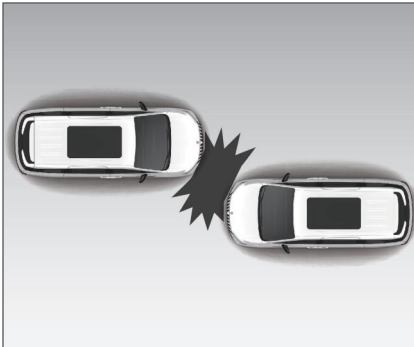

The vehicle collides with a stationary frontal vehicle of the same weight, or the collision direction and point deviate from the centre of the vehicle by more than 30 degrees.



- Rollover.

- Side collision, rear collision, slight frontal collision.
- The airbag system is faulty.
- Other special circumstances.

## Types of collision without deployment of front side airbags and side curtain airbag \*

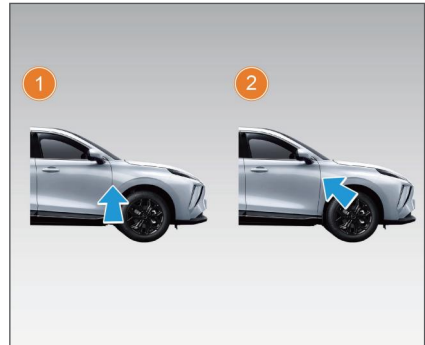

1. Side collision of the vehicle body (not involving the passenger compartment)
2. Side collision at an angle

The front side airbag and side curtain airbag may not deploy if the vehicle is involved in a side collision at a certain angle to the vehicle body, or if the side collision occurs at a part of the vehicle body other than the passenger compartment.



1. Rear Collision
2. Rollover

## Safety and Protection

The front side airbag and side curtain airbag may not be deployed in case of rear collision, rollover and low-speed side collision.





If the vehicle suffers a frontal collision or a near-frontal collision, the front side

airbags and side curtain airbags may not deploy.

### Airbag indicator

Before driving and after the vehicle is powered on, the SRS will conduct self-inspection. At this moment, the SRS MIL  will illuminate and then go out a few seconds later.

If the following situations occur, please contact the Forthing service station:

1. After the vehicle is powered on, the SRS MIL  does not light up.
2. After the vehicle is started, the SRS MIL  remains on.
3. The SRS MIL  illuminates or flashes during driving.

### Event Data Recorder (EDR)

The vehicle is equipped with an event data recorder (EDR). The recorded data can be used for collision accident analysis. See the following table for specific parameters:

S/N	Parameter name	Meaning	Unit
1	Longitudinal delta-V	Change in longitudinal speed of the vehicle.	km/h
2	Maximum recorded longitudinal delta-V	Maximum cumulative change in longitudinal vehicle speed.	km/h
3	Maximum recorded longitudinal delta-V time	The time when the maximum cumulative change in longitudinal vehicle speed is reached.	ms
4	Clipping sign	It indicates the point in time when the EDR acquisition acceleration (lateral and longitudinal) reaches the sensor range for the first time.	ms
5	Vehicle speed	Wheel-hub linear speed.	km/h
6	Service brake, on or off	Used to detect whether the driver depresses the brake pedal.	/
7	Driver's seat belt status	Driver seat belt buckled or unbuckled.	/

S/N	Parameter name	Meaning	Unit
8	Accelerator pedal position, percentage of fully open position	The percentage of the actual accelerator pedal position to the fully depressed position by the driver.	/
9	Power-up period during the event	Number of power cycles of the ECU for recording EDR data from the first service time of the ECU to the event occurrence time.	Cycle
10	Power-up period when reading	Number of power cycles of the ECU for recording EDR data from the first service time of the ECU to the data reading time.	Cycle
11	Completeness status of event data record	Whether the event is completely recorded.	/
12	Time interval between current event and previous event	Time interval between two events.	s
13	VIN	Vehicle VIN.	/
14	Hardware number of the ECU recording the EDR data	Hardware number of the EDR device.	/
15	ECU S/N for recording EDR data	Product serial number of the EDR device.	/
16	Software number of the ECU recording the EDR data	Software number of the EDR device.	/
17	Longitudinal acceleration	Component of vector acceleration at a point on the vehicle in the X-axis direction.	g
18	Lateral acceleration	Component of vector acceleration at a point on the vehicle in the Y-axis direction.	g
19	Lateral delta-V	Change in lateral speed of the vehicle. Lateral delta-V is only the component of total delta-V in the Y-axis direction.	km/h
20	Maximum recorded lateral delta-V	Maximum value of cumulative change in the vehicle speed along Y-axis direction recorded by EDR.	km/h
21	Maximum record of square of resultant delta-V	The maximum value of the sum of squares of longitudinal delta-V and lateral delta-V recorded by EDR.	(km/h) <sup>2</sup>
22	Time elapsed for reaching maximum record of square of resultant delta-V	EDR records the time taken for the cumulative change of vehicle speed in Y-axis direction to reach the maximum value.	ms

## Safety and Protection

S/N	Parameter name	Meaning	Unit
23	The time to reach the maximum recorded resultant delta-V	The time taken for the sum of the squares of the longitudinal delta-V and the lateral delta-V recorded by the EDR to reach the maximum value.	ms
24	Yaw rate	The change of vehicle angle relative to Z-axis before and during the event, which is applicable to vehicles with electronic stability control system.	%s
25	Steering angle	The angular coordinates of the steering wheel are applicable to vehicles equipped with steering angle sensors.	°
26	Tend	It is the end point of the impact event. If the condition is not met until the end of the recording period, Tend can be defined as the time of the last recorded data point.	ms
27	Year	The year when the event occurs.	/
28	Month	The month when the event occurs.	/
29	Day	The date when the event occurs.	/
30	Hour	Time of event.	/
31	Minute	Time of event.	/
32	Second	Time of event.	/
33	Gear	Actual gear, which is applicable to vehicles with bus transmitting this signal.	/
34	Brake pedal position	Actual position of brake pedal, applicable to vehicles with brake pedal position sensor.	%
35	Parking system status	It is used to detect whether the parking brake is activated. It is applicable to vehicles with their parking system status transmitted through the Bus.	/

S/N	Parameter name	Meaning	Unit
36	Direction indicator switch status	Status of the switch used to indicate the vehicle's intention to turn or change lane, which is applicable to vehicles with a bus transmitting direction indicator signals.	/
37	Deployment time of driver's seat belt pretensioner	The time from the start of the event to the ignition command of the driver's seat belt pretensioner.	ms
38	Deployment time of driver's frontal airbag (first stage)	The time from the start of the event to the first stage of the driver frontal airbag issuing the ignition command.	ms
39	Deployment time of driver's frontal airbag (second stage)	The time from the start of the event to the second stage of the driver frontal airbag issuing the ignition command.	ms
40	Deployment time of driver's side airbag	The time from the start of the event to the ignition command from the driver side airbag.	ms
41	Deployment time of driver's side curtain airbag	The time from the start of the event to the ignition command from the driver side curtain airbag device.	ms
42	Front passenger's seat belt status	Front passenger's seat belt buckled status, which is applicable to vehicles equipped with seat belt reminder.	/
43	Deployment time of front passenger's seat belt pretensioner	The time from the start of the event to the ignition command from the front passenger seat belt pretensioner.	ms
44	Front passenger's frontal airbag suppression status	Suppression status indicated for the front passenger's frontal airbag, which is applicable to vehicles with frontal airbag suppression switch.	/
45	Deployment time of front passenger's frontal airbag (first stage)	The time from the start of the event to the first stage of the ignition command of the front passenger frontal airbag.	ms
46	Front passenger's frontal airbag deployment time (second stage)	The time from the start of the event to the second stage of the ignition command of the front passenger frontal airbag.	ms
47	Deployment time of front passenger side airbag	The time from the start of the event to the ignition command from the front passenger side airbag.	ms
48	Deployment time of front passenger side curtain airbag	The time from the start of the event to the ignition command from the front passenger side curtain airbag device.	ms

## Safety and Protection

S/N	Parameter name	Meaning	Unit
49	Occupant protection system alarm status	Fault status of passenger protection system, which is applicable to vehicles with a bus transmitting occupant protection system alarm status.	/
50	Alarm status of tyre pressure monitoring system	Alarm status when the on-board tyre pressure monitoring system monitors low pressure of one or more tyres, which is applicable to vehicles with a bus transmitting this alarm status.	/
51	Brake system alarm status	Fault status of brake system, which is applicable to vehicles with a bus transmitting this alarm status.	/
52	Cruise control system status	Operating status of cruise control system.	/
53	Adaptive cruise control status	Operating status of adaptive cruise control.	/
54	ABS status	The operating status of anti-lock brake system, which is applicable to vehicles with a bus transmitting the anti-lock brake system status.	/
55	Autonomous emergency brake system status	Operating status of the autonomous emergency braking system.	/
56	Electronic stability control system status	Operating status of the electronic stability control system.	/
57	Traction control system status	Operating status of the traction control system.	/
58	Pre-event synchronous timing period	The relative time from the last data sampling point before T0 to T0, which is applicable to vehicles with pre-event synchronization timing function. It is used for time alignment of different data.	ms

The EDR system is integrated in the airbag controller. The recorded data can be extracted through the special diagnostic equipment of an authorised Forthing service station.

The vehicle speed recorded by the EDR system comes from the wheel linear speed of the anti-lock brake system (ABS) equipped on this vehicle.

The data recorded by the EDR system is divided into unlocked event data and locked event data. The former is the data recorded when EDR recording conditions are met but airbag deployment conditions are not met. The latter is the data recorded when the SRS deployment conditions are met. The unlocked event data overwrites the previous unlocked event data in chronological order; the locked event data cannot be overwritten by the data of subsequent events, and a total of three event data can be recorded.

## Children protection measures

### Riding Instructions for Children

When a child is in the vehicle, please be sure to read this chapter.

If a child is too young to wear the seat belt, he/she shall be placed in a rear approved child safety seat.

To ensure safety and stability, it is recommended to use a child safety seat that is suitable for children and complies with relevant regulations or standards.

Older children must wear a three-point seat belt for protection, and if necessary, an auxiliary safety cushion shall be installed.

During driving, please use the rear door child safety lock and window lock switch to prevent children from opening the door or accidentally operating the power window.



#### Warning

- Please use the child safety lock to prevent children from opening the rear door and being thrown out of the vehicle accidentally.
- Do not allow multiple children to share a child safety seat at the same time.
- Make sure there are no hard or sharp objects on the child safety seat to prevent personal injury in the event of an accident.

### Protective measures for infants

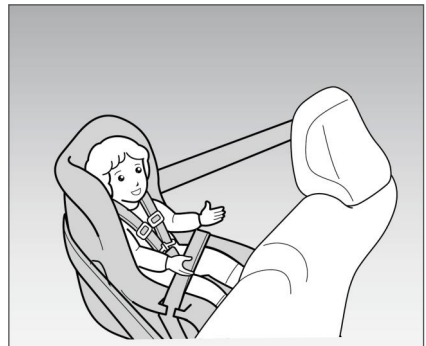

The neck of an infant under one year old is very fragile. If you ride facing forward, it is easy to cause neck injury in case of a frontal collision. Therefore, it is recommended to use a rear-facing child restraint system.



#### Warning

- Children shall not sit in the front passenger seat.
- Do not leave a child alone in the vehicle, which may cause injuries or deaths of children in an airtight vehicle due to excessively high temperature.
- Do not allow any child to kneel on the seat or stand in the vehicle when the vehicle is running.
- Do not allow children to carry or use the smart key, as they may start the vehicle or shift to N gear. A child may also hurt himself/herself when playing with windows, panoramic sunroof or other vehicle equipment.

## Safety and Protection

### Protective measures for young children



According to the weight and height requirements specified by the manufacturer of child restraint system, children over one year old should use forward-facing child restraint system when riding.

### Protective measures for older children



It is recommended that all children under 12 years of age be seated in the rear seat and protected. If the seat belt does not fit properly, an auxiliary seat cushion can be installed for children.

### Applicable information of child restraint system

Although all weight categories can

occupy any passenger seat model, the type of child restraint system that can be used for each seat may vary. For example, only seat belt-based child restraint system (defined in both installation methods) can be used in the middle seat of the second row.

Please select child restraint system that comply with AS/NZS 1754. For more information on child seats, please visit [www.childcarseats.com.au](http://www.childcarseats.com.au).



#### Warning

To ensure the safety of infants and young children, it is recommended to purchase new child restraint system. Please pay attention to the following warnings:

- Do not use child restraint system older than 10 years.
- Ensure that the child restraint system complies with AS/NZS 1754. This information shall be displayed on the label attached to the child restraint system.
- Verify that the child restraint system is not used in the vehicle involved in a collision.
- Ensure that all parts of the child restraint system (such as retaining rings) operate smoothly and show no signs of wear or damage (such as cracks and ruptures).
- Make sure that the seat belt on the child restraint system is not worn, damaged or loose.
- Ensure that the child restraint system has a User's Manual.

## Compatibility of each seat position with the child restraint system

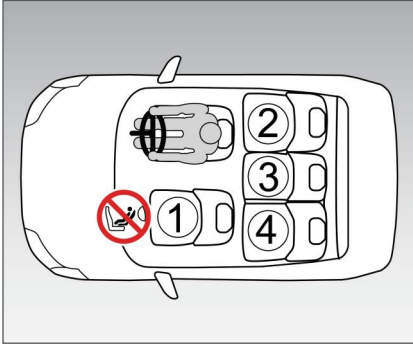

①	/
② *1	UF ISOFIX
③ *1,2	UF
④ *1	UF ISOFIX

**UF** Applicable only to forward-facing "universal" child restraint system that are fixed with seat belts.

**ISOFIX** Applicable to ISOFIX child restraint system.

Including top fixing points.

Front passenger frontal airbag activated. It is prohibited to use rear-facing child restraint system on the front passenger seats.

\*1: If the headrest interferes with the child restraint system and is removable, remove the headrest; otherwise, adjust the headrest to the highest position.

\*2: Only forward-facing child restraint system can be used.

# Safety and Protection

## Installation details of child restraint system

Categories of child restraint system	Seat Position			
	①	②	③	④
Applicable only to forward-facing, "universal" child seats secured with seat belts (Yes/No)	No	Yes	Yes	Yes
ISOFIX seat position (Yes/No)	No	Yes	No	Yes
Applicable to side mounting devices(L1/L2/No)	No	No	No	No
Applicable to rear-facing devices (R1/R2X/R2/R3/No)	No	R1, R2X, R2, R3	No	R1, R2X, R2, R3
Applicable to forward-facing devices(F2X/F2/F3/No)	No	F2X, F2, F3	No	F2X, F2, F3
Fixing device suitable for older child seats(B2/B3/No)	No	B2, B3	No	B2, B3

ISOFIX child restraint system are divided into different "device types". The child restraint system can only be used in the seat position corresponding to the "device types" indicated in the table.

Device code	Description
F3	Full-height forward-facing child restraint system
F2	Standard height forward-facing child restraint system
F2X	Reduced-height forward-facing child restraint system
R3	Full-size rear-facing child restraint system
R2	Standard-size rear-facing child restraint system
R2X	Reduced-size rear-facing child restraint system
R1	Rear-facing baby safety carrier
L1	Left lateral-type (basket type) infant seat
L2	Right lateral-type (basket type) infant seat
B2	Booster seat
B3	Booster seat

## Installation of rear-facing child restraint system

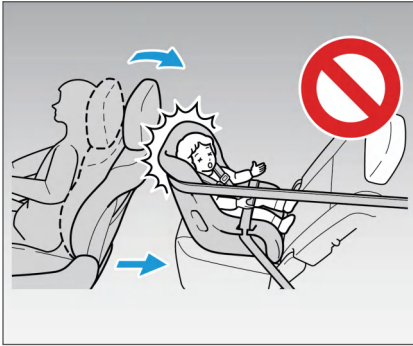

If the rear-facing child restraint system is obstructed by the driver's seat and thus cannot be installed correctly, the rear-facing child restraint system should be installed on the left rear seat.

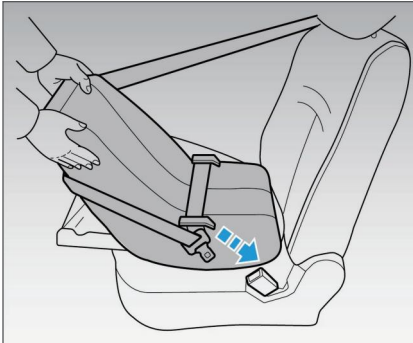

According to the instructions provided by the manufacturer, pass the seat belt through or around the rear-facing child restraint system, and then insert the latch plate into the buckle to ensure that the seat belt is not twisted and remains tight. Make sure that the latch plate and buckle are firmly locked, and shake left and right to ensure that the child restraint system is firmly fixed.

## Installation of forward-facing child restraint system

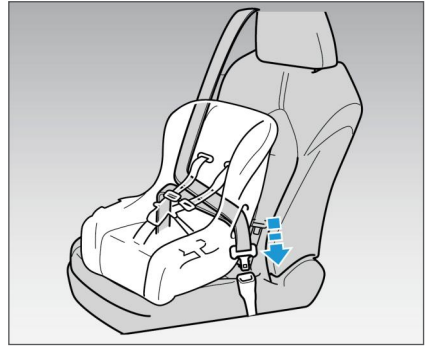

According to the instructions provided by the manufacturer, pass the seat belt through the forward-facing child restraint system and insert the latch plate into the buckle, ensuring the seat belt is not twisted and remains tight. Confirm that the latch plate and buckle are firmly locked, press the child restraint system against the seat cushion and seat backrest to fully retract the seat belt, so that the child restraint system is firmly fixed, and shake it left and right to ensure that the child restraint system is firmly fixed.

## Installation of Auxiliary Seat Cushion



Place the auxiliary cushion on the seat

## Safety and Protection

and let the child sit on the auxiliary cushion. According to the instructions provided by the manufacturer, correctly cross the seat belt over the child's shoulder, lower the lap belt as low as possible to the child's hip position, and then insert the latch plate into the buckle to ensure that the seat belt is not twisted and kept tight.

### Child Safety Seat

Please use a child safety seat suitable for children and in compliance with relevant regulations or standards.



There are warning labels on the front and back of the front passenger sun visor, reminding that this vehicle is equipped with front airbags. Please pay attention to relevant matters.

#### Warning

Do not use rear-facing child restraints on seats protected by frontal airbags (in the activated state)!

### Installation of child restraint system



1. Locate the ISOFIX interface in the gap between the rear seat cushion and the backrest.



2. Align the ISOFIX interface of the child restraint system with the corresponding ISOFIX interface at the bottom of the seat cushion, inserting the rigid interface

and buckling the elastic interface.



3. Lift the headrest to a suitable position, pass the hook of the child safety device under the seat headrest, and fasten it to the fixed anchor support on the back of the seat. Be careful not to twist the top tether.

4. Tighten the top tether and push and pull the child seat in different directions to ensure that it is firmly fixed.



### Warning

- If a child safety seat is installed on the rear seat, the driver and front passenger should keep a distance of 50 mm between the seat and the child safety seat when adjusting the seat backward or backrest angle.
- Do not use one tether or one fixture to install multiple child safety seats. Multiple child safety seats will increase the burden on the tethers or fixing devices, which may cause damage to the tethers or fixing devices, resulting in serious personal injury or death.
- If the child is too old to use a child seat, he should sit in the back seat and use the seat belt correctly.

03



### Warning

- The fixing device of the child safety seat can only withstand the load generated by a properly installed child safety seat. Under no circumstances shall the above fixings be used as adult seat belts or seat belts. Otherwise, personal injury may be caused in a vehicle collision.
- After the child safety seat is installed, please do not continue to adjust the seat, otherwise it may cause the child safety seat to shift and fail to provide protection.
- Do not hold infants and young children in your arms when riding in the car. They shall be placed in a suitable child safety seat.

### **Warning lights and indicators ..... 43**

Warning light..... 43

Indicator ..... 44

### **Instrument cluster control .....47**

### **Overview of instrument cluster ..... 48**

Left information display area  
.....49

Right information display  
area ..... 49

## Warning lights and indicators

Warning light and indicator light remind the driver of the status of various systems in the vehicle.



### Warning light

The warning light prompts the driver that some systems of the vehicle may be faulty.

#### Tire pressure monitoring system fault warning light



When the tire pressure/temperature is abnormal, this indicator will be on. Please park the vehicle in a safe place in time and adjust the tire pressure or restore the tire temperature to a normal state. If this indicator is still on after the above operations, please contact a Forthing service station in time.

When the tire pressure monitoring system is not matched or the sensor signal is lost, this indicator flashes. Please contact a Forthing service station in time.

#### EPB system fault warning light



This indicator will be on when parking system is faulty. When the EPB system signal is lost, this indicator will flash. Please contact

a Forthing service station in time.

#### Abnormal charging warning light of 12V low-voltage battery



When the 12V low-voltage battery is charged abnormally,

this indicator will be on. At this time, please turn off all unnecessary electrical equipment or depress the brake pedal to make the vehicle enter the READY state. If this indicator still does not go out, please contact a Forthing service station in time.

#### Power steering system fault warning light



When the EPS system has a minor fault, this indicator turns orange; when a serious fault occurs, this indicator turns red.

If this light is on when the vehicle is running, please reduce the speed in time and park the vehicle safely on the roadside. Power off the vehicle and restart it. If this indicator no longer illuminates, the vehicle can run normally. If this indicator still illuminates continuously, please contact a Forthing service station as soon as possible.

## Instrument Cluster

### ABS system fault warning light



If this light illuminates during driving, it means that the anti-lock brake system (ABS) is faulty. At this time, although the vehicle has normal braking capacity, it does not have an anti-lock braking function. Please drive carefully and contact a Forthing service station as soon as possible.

### Low brake fluid level/Braking system fault warning light



This light will illuminate when the brake fluid level drops to a low level. If this light illuminates when the vehicle is running, the brake system may be faulty. Please drive the vehicle away from the road carefully, stop the vehicle safely, and contact a Forthing service station in time.

### Forward collision assist indicator\*



When the forward collision assist function fails or is turned off, this indicator will stay on; when the forward collision assist function alarms, this indicator flashes.

### Airbag system fault warning light



If this light continues to illuminate during driving, indicating that the airbag system is faulty. Please contact a Forthing service station.

### Front seat belt warning light



After the vehicle is powered on, if the driver or front passenger does not wear their seat belts properly, this light will be on and accompanied by an alarm sound. If the driver or front passenger fails to wear

their seat belts properly, this indicator will go out, and the alarm will be released.

### Rear seat belt warning light



After the vehicle is powered on, if the rear passenger does not wear his seat belt, this indicator will be on until the rear passenger fastens their seat belt.

### ADAS system fault warning light\*



When the ADAS system fails, this light will be on. Please contact a Forthing service station in time.

### Fault warning light



When this warning light illuminates, it indicates that some functions of the vehicle are abnormal. If the alarm cannot be cleared after handling, please contact a Forthing service station.

### Power system fault warning light



When the vehicle power system fails, this indicator will illuminate and the text alarm on the instrument cluster will prompt the cause of the fault. If the fault cannot be eliminated, please contact a Forthing service station in time.

### Indicator

The indicator light is used to inform the driver of the working status of each system of the vehicle. When it is on or flashing, it is in normal status in most cases, and the vehicle is not faulty.

### Turn and hazard signal indicator



When the turn signal is operated, the corresponding

turn indicator flashes or goes out. This indicator light and the left and right turn signals will flash at the same time when the hazard warning light switch is pressed. If it does not flash or flashes quickly at this time, it means that the turn signal bulb may be faulty. Please contact a Forthing service station for inspection or replacement.

### Parking status indicator



After the vehicle stops, press the P gear button and this indicator will light up. If this

indicator does not illuminate or flashes continuously after parking, it indicates that the parking brake may be faulty or there is a risk of parking. Please contact a Forthing service station.

### AUTO HOLD ON indicator



This indicator illuminates when the automatic parking function is enabled but not activated.

### AUTO HOLD activation indicator



When the automatic parking function is activated, this indicator will be on.

### HDC activation indicator



When the HDC function is enabled but not activated, this indicator stays on. This indicator flashes when the HDC system is activated.

### Position light indicator



This light illuminates when the position light is turned on.

### Low beam indicator



This light illuminates when the

low beam is turned on.

### High beam indicator



This light illuminates when the high beam is turned on.

### Rear fog light indicator



This light illuminates when the rear fog light is turned on.

### ESP OFF indicator



This indicator will be on when the ESC system is turned off.

### ESP activation indicator/fault indicator



This indicator flashes when the ESC system is working. If the indicator stays on during driving, it indicates a possible fault in the ESC system. Please contact a Forthing service station.

### Intelligent high beam ON (not activated) indicator\*



When the intelligent high beam control function is enabled but not activated, this indicator will

light up.

### Intelligent high beam activation indicator\*



When the intelligent high beam control function is activated, this indicator will light up.

### Intelligent high beam fault indicator\*



When the intelligent high beam control function fails, this indicator will be on.

### Lane departure assist activation indicator\*



When the vehicle deviates from the lane, this indicator will be on to remind the driver to correct it in time or the vehicle to correct it actively.

# Instrument Cluster

## Lane departure assist fault indicator\*



When the vehicle departure assist function fails, this indicator will be on.

## Limited power status indicator



When the vehicle is in limited power (limp) mode, this indicator lights up. At this time, be careful, slow down or stop for inspection, and continue driving after clearing the fault.

## System ready (READY) indicator



This indicator illuminates when the brake pedal is depressed after the vehicle is powered on.

## OPM indicator



When the enhanced regen braking is activated, this light lights up, indicating that the vehicle is in the single-pedal driving status.

## Driving mode status indicator



It indicates the current driving mode. When the vehicle is in Eco/Sport/Normal mode, this indicator will be on.

## Charging connection indicator



When the charging/discharging plug is inserted, this indicator will light up.

This indicator flashes during charging/discharging.

When the charging/discharging plug is abnormally connected or the charging fails, this indicator will be always on and a text alarm prompt will be displayed on the instrument cluster.

## Cruise control ON (not activated) indicator



This indicator illuminates when the cruise control system is turned on but not activated.

## Cruise control activated indicator



This indicator is on when the cruise control is activated and starts working.

## ACC cruise ON (not activated) indicator\*



This indicator is on when the ACC cruise activation conditions are met and ACC can be activated. Among them, 120 is the target speed during cruising, which shall be subject to the actual displayed number.

## ACC cruise activation indicator\*



This indicator is on when the ACC cruise is activated and starts working. Among them, 120 is the target speed during cruising, which shall be subject to the actual displayed number.

## Power battery low SOC indicator



When the power battery SOC is too low, this indicator will be on. Please charge the power battery in time.

## Instrument cluster control

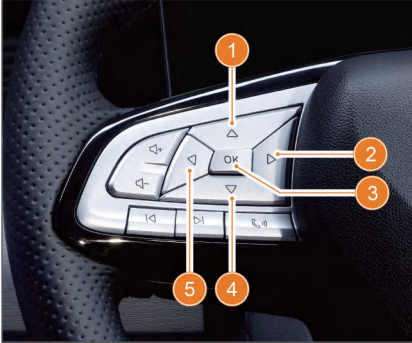

1. Up button: Increase the brightness of instrument cluster.
2. Right button: Switch to the same level page.
3. OK button: Long press (more than 2 seconds) to reset the subtotal mileage.
4. Down button: Decrease the brightness of instrument cluster.
5. Left button: Switch to the same level page.

## Overview of instrument cluster

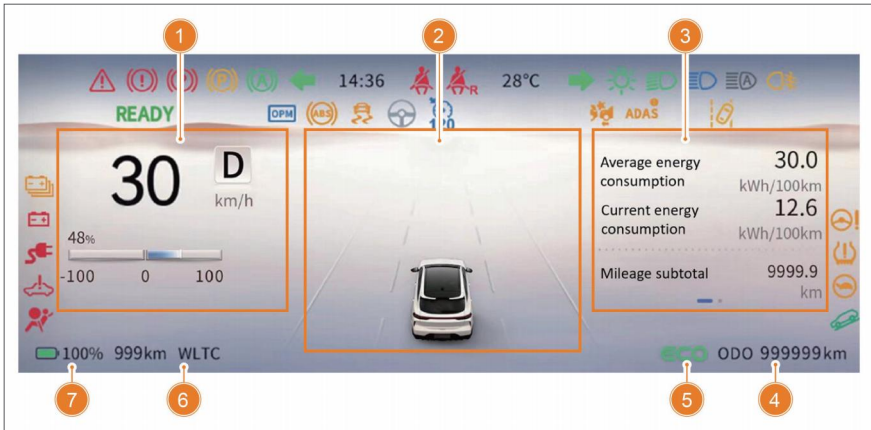

### 1. Left information display area

(1) Real-time vehicle speed status: Display the real-time vehicle speed, current gear and power meter.

(2) Charging/discharging status: It displays the current charging/discharging information.

### 2. Text alarm/driver assistance display area

(1) Display text prompt.

(2) Display the vehicle model, lane line, and other driver assistance related information. See relevant instructions in the chapter of "Comfortable Driving" for details.

### 3. Right information display area

The displayed vehicle information can be switched by pressing the left and right buttons on the left side of the steering wheel.

### 4. Total mileage

Displays the total mileage the vehicle has traveled.

### 5. Driving mode

Display the current driving mode of the vehicle. After the driving mode is switched on the multimedia display, the instrument cluster switches synchronously. For details, please refer to the "Driving Mode" content in the "Comfortable Driving" chapter.

### 6. Driving range standard

Display the estimated driving range of endurance standard and power battery SOC. After the endurance standard is switched on the energy center interface of the multimedia display, the endurance standard will be updated synchronously on the instrument cluster interface.

### 7. SOC indicator

Display the current remaining SOC of the vehicle and the driving range under relevant standard endurance conditions.

## Left information display area

This interface displays real-time driving state and charging information.

### Driving state



#### 1. Speedometer

Display the current speed of the vehicle.

#### 2. Current gear

According to the gear currently selected by the driver, it is displayed as R, N and D. When the vehicle is in P gear, the gear position is displayed on the speedometer.

#### 3. Power meter

Display real-time power output and energy recovery percentage, kinetic energy recovery range: -100 ~ 100%. Positive values indicate energy output and negative values indicate energy recovery.

## Charging/discharging status

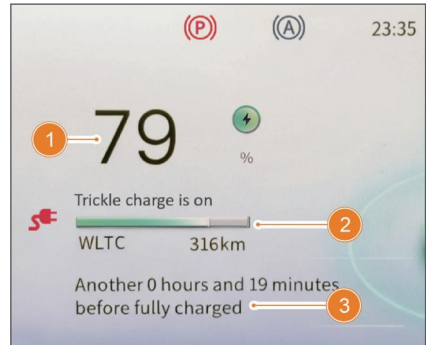

#### 1. Current SOC of power battery

#### 2. Current battery driving range

#### 3. Remaining charging time

04

## Right information display area

The displayed vehicle information can be switched by pressing the left and right buttons on the steering wheel.

### Vehicle status

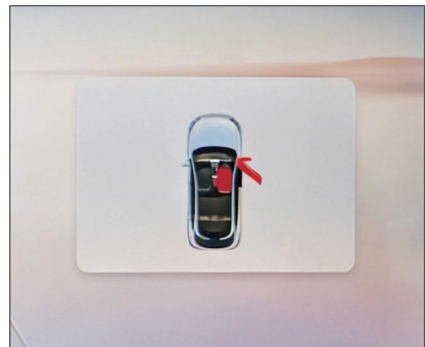

Display the status of unfastened seat belts and doors. Only after all doors are closed and seat belts are fastened can other interface information be switched to view.

# Instrument Cluster

## Energy consumption information

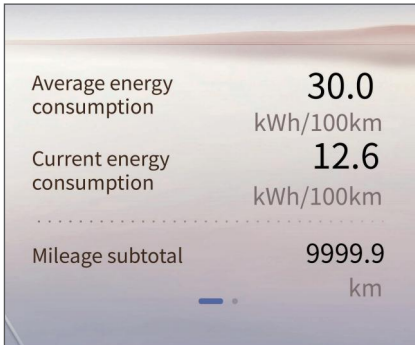

Display the average energy consumption, current energy consumption and mileage subtotal of the vehicle.

## Tire pressure information

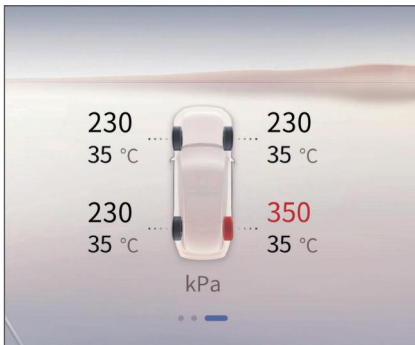

When the tire temperature/tire pressure is abnormal, the instrument cluster will remind the driver of the abnormal tire position.



## Caution

- Please keep the tire pressure near the standard pressure value. When the tire pressure is displayed as "--" and the designated tire position is on, it indicates that the tire pressure monitoring system has lost the sensor at this position. Please contact a Forthing service station in time.
- As long as the tire pressure sensor is not replaced or damaged due to tire repair, tire removal and other reasons, it is not necessary to re-match the tire pressure sensor. However, if the tire position is changed or the tire pressure sensor in the tire is replaced, it is necessary to re-match the tire pressure. Please contact a Forthing service station.

## Introduction to Keys..... 53

- Smart key .....53
- Take out the mechanical key  
.....53
- Battery swap .....53
- Immobiliser system .....54

## Opening, Closing and

### Locking of Door ..... 54

- Unlock and lock door from the  
outside .....54
- Internal door unlocking and  
locking .....56
- Rear door child safety lock 56
- Automatic locking of door ..56
- Forced unlocking on collision  
.....57

### Opening and closing of boot lid ..... 57

- Open the boot lid from the  
outside .....57
- Close the boot lid from the  
outside .....57
- Opening and closing of boot  
lid from the inside\* .....58
- Interior emergency opening of  
boot lid .....58
- Boot lid opening height

- settings\* .....58

## Seat ..... 60

- Front seats .....60
- Rear seat .....62
- Seat memory\* .....63
- Headrest .....63

## Steering Wheel..... 64

- Steering Wheel Adjustment 64
- Horn .....65
- Steering wheel button (left)65
- Steering wheel button (right)  
.....65

## Interior rearview mirror ... 66

- Anti-dazzling adjustment of  
interior rearview mirror .....66

## Exterior rearview mirror.. 67

- Electric adjustment of exterior  
rearview mirror .....67
- Folding and unfolding exterior  
rearview mirror .....67
- Heating & defrosting of  
exterior rearview mirror .....68

## Power window..... 68

- Manual opening/closing of  
windows .....68
- Automatic opening/closing of  
windows .....68

Remotely opening/closing windows .....	68
Window lock switch .....	69
Window thermal protection	69
Auto window closing during rain* .....	69
Window anti-pinch protection .....	69
<b>Sunroof* .....</b>	<b>70</b>
Panoramic sunroof .....	70
<b>Lights.....</b>	<b>72</b>
Exterior lighting.....	72
Interior light.....	73
<b>Wiper.....</b>	<b>74</b>
Front manual wiper .....	74
Front automatic wiper* .....	74
Rear wiper .....	75
<b>Type-C interface.....</b>	<b>76</b>
<b>USB interface .....</b>	<b>77</b>
USB media source interface at the front of dashboard ...	77
Rear USB interface of auxiliary dashboard.....	77
<b>12V on-board power supply .....</b>	<b>77</b>
<b>Wireless charging* .....</b>	<b>78</b>
<b>Dashcam* .....</b>	<b>79</b>
Insertion and extraction of memory card.....	79
Operation of dashcam .....	79
<b>A/C system .....</b>	<b>80</b>
A/C control panel .....	80
A/C interface on the multimedia display screen .	80
Position of air outlet .....	83

## Introduction to Keys

### Smart key

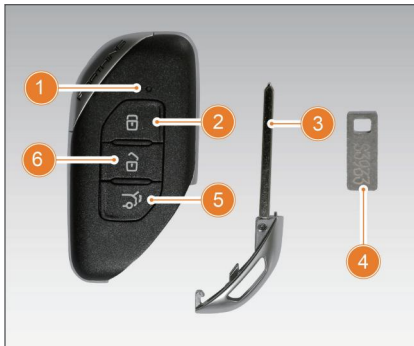

1. Smart key indicator
2. Lock button
3. Mechanical key
4. Mechanical key number plate
5. Boot lid Button
6. Unlock button

If the mechanical key is lost, the mechanical key from another smart key can be taken out and used for reconfiguration.

### Take out the mechanical key



Press the mechanical key release button on the side of the smart key to take out the mechanical key.

### Battery swap

The battery in the smart key shall be

replaced when the remote control distance of the smart key becomes shorter or the vehicle cannot be remotely controlled, or the vehicle fails to recognise the smart key due to low battery. Battery model: CR2032 3V.

If the key battery needs to be replaced, it is recommended to visit a Forthing service station.

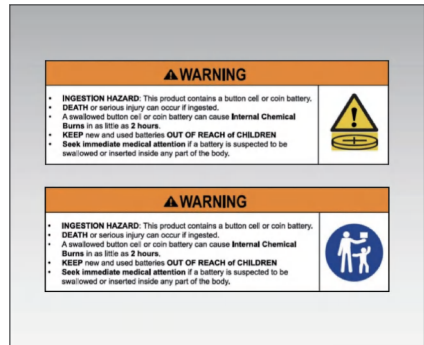

05

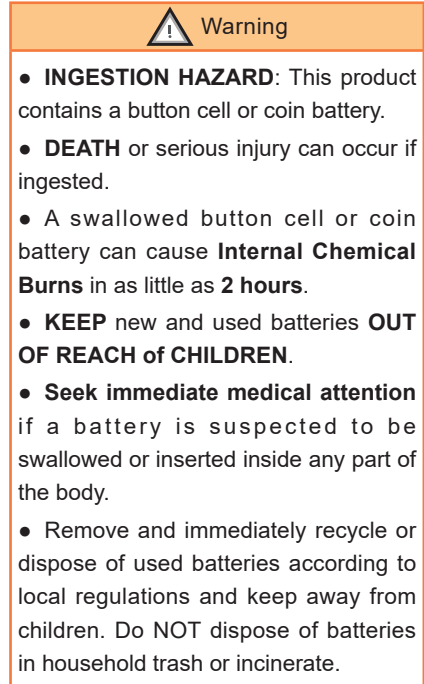



### Warning

- Even used batteries may cause severe injury or death.
- Call a local poison control center for treatment information.
- Non-rechargeable batteries are not to be recharged.
- Do not force discharge, recharge, disassemble, heat above (manufacturer's specified temperature rating) or incinerate. Doing so may result in injury due to venting, leakage or explosion resulting in chemical burns.
- Ensure the batteries are installed correctly according to polarity (+ and -).
- Do not mix old and new batteries, different brands or types of batteries, such as alkaline, carbon-zinc, or rechargeable batteries.
- Remove and immediately recycle or dispose of batteries from equipment not used for an extended period of time according to local regulations.
- Always completely secure the battery compartment. If the battery compartment does not close securely, stop using the product, remove the batteries, and keep them away from children.

### Immobiliser system

If an incorrectly coded smart key is used, the vehicle cannot be unlocked. At this time, when the door handle is pulled or other actions are made to trigger immobiliser, the vehicle horn alarm reminds, indicating that the immobiliser function is enabled. When the immobiliser system cannot recognise the key code,

please contact a Forthing service station.

## Opening, Closing and Locking of Door

### Unlock and lock door from the outside

#### Keyless entry



#### Unlocking

Carry the smart key and hold the inner unlocking area of the driver's door handle to unlock all doors.

#### Locking

Carry the smart key, close all doors, and press the locking area on the driver's door handle to lock all doors.



### Caution

After the vehicle is locked with smart key, passengers in the vehicle can still open the door to get off through the inner handle of the door, but an alarm will be triggered. It is recommended to unlock the door before getting off.

## Unlocking and locking with smart key



### Unlocking

Short press the unlock button on the smart key, and then the four doors will be unlocked, the direction indicator will flash twice, and the position light is on; long press the unlock button, and then the glasses of the four doors will open.

### Locking

Short press the lock button on the smart key to lock the four doors. When the vehicle is locked, the direction indicators will light up once, the horn will sound once, and the IVI system will be turned off (locking feedback needs to be activated); long press the lock button to close the four door glasses and sunroof (some models).

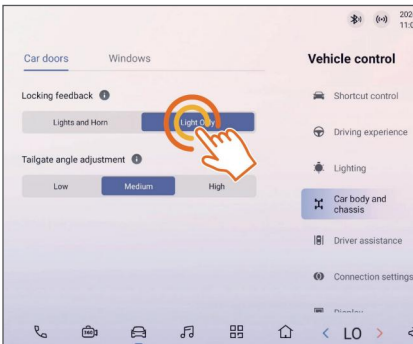

Tap [Vehicle control] - [Car body and chassis] - [Car doors] in the bottom

navigation bar of the multimedia display screen. You can choose to lock the car feedback as [Lights and Horn] or [Light Only].

## Unlocking and locking with mechanical key

1. Take out the mechanical key from the smart key.



2. After the door is closed, pull the driver's door handle to the maximum opening, put the index finger into the handle and press the front clip, and take out the lock cylinder cover to expose the lock cylinder hole.



3. Insert the mechanical key into the lock cylinder hole, and turn the key counterclockwise to unlock the door; turn the key clockwise to lock the door.

4. Take out the mechanical key and put the lock cylinder cover back on the door

# Operation of Basic Functions

handle.

## Internal door unlocking and locking

### Unlocking with the interior door handle



When the door is locked, pull the interior door handle twice to open the door.

When the door is unlocked, pull the interior door handle once to open the door.



### Caution

When the child safety lock of the rear door is locked, the door cannot be opened from inside.

### Central door lock unlocking and locking



1. Lock button

2. Unlock button

With all doors (including the boot lid) closed, press the lock button to lock all

doors.

With all doors (including the boot lid) locked, press the unlock button to unlock all doors.

### Unlocking and locking of front passenger door and rear door



If the vehicle is powered off, press the inner switch of the door lock to close the door, and then the door can be locked. Pull the inner door handle from the inside of the vehicle twice to unlock the door.

### Rear door child safety lock



1. Locking

2. Unlocking

After the rear door child safety lock is set, children cannot open the rear door from inside, which helps to prevent children from accidentally opening the rear door.

### Automatic locking of door

With the doors unlocked, when the vehicle speed increases to more than 10 km/h, the four doors will be locked automatically.

### Forced unlocking on collision

When the doors are locked and the start switch is in the ON position, if the vehicle suffers a strong impact, all doors will automatically unlock to facilitate passengers to leave the vehicle quickly. Whether to unlock automatically depends on the specific impact force and accident type.

### Opening and closing of boot lid

Open the boot lid from the outside

Keyless opening of boot lid



#### Normal boot lid

Carry the smart key to the side of the boot lid, press the microswitch and manually open the boot lid.

#### Power boot lid\*

Carry the smart key to the side of the boot lid and press the microswitch to automatically open the boot lid.

Opening boot lid with smart key



#### Power boot lid\*

When the boot lid is closed, press and hold the boot lid button on the smart key, and the boot lid will open automatically.

Close the boot lid from the outside

Keyless closing of boot lid

#### Normal boot lid



Push down the boot lid to close it.

## Operation of Basic Functions

### Power boot lid\*



Press the boot lid shield switch to automatically close the boot lid. If this switch is pressed again during closing, the boot lid will stop closing.

### Closing boot lid with smart key\*

In addition, the boot lid can be closed automatically by pressing and holding the boot lid button on the smart key.

### Opening and closing of boot lid from the inside\*



Press the interior boot lid switch to open or close it from inside.

### Interior emergency opening of boot lid

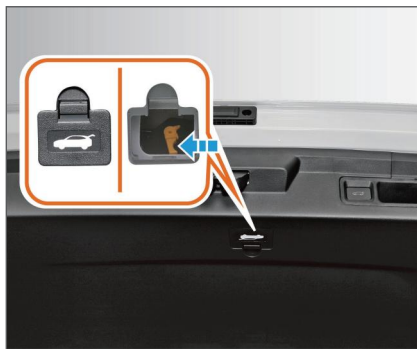

If the unlocking device fails or is trapped in the vehicle and the boot lid cannot be opened from outside, you can first remove the emergency opening cover plate on the inner shield of the boot lid, push the emergency opening handle of the boot lid lock body to the left, and push the boot lid outward at the same time with your other hand to open the boot lid from inside.

### Boot lid opening height settings\*



### Set the opening height of boot lid

The opening height of the boot lid can be set through the boot lid shield switch:

1. Manually open the boot lid to the required height.
2. Press and hold the boot lid shield

switch until a sound signal is heard, indicating that the opening height is set successfully.

3. Close the boot lid and reopen it to the set height.

### Restore the maximum opening height

1. Manually open the boot lid to the highest position.

2. Press and hold the boot lid shield switch until a sound signal is heard, indicating that the maximum opening height is restored successfully.

3. Close the boot lid and reopen it to the maximum height.



### Warning

- Do not open or close the power boot lid manually unless necessary.
- When the power boot lid needs to be manually operated in case of power failure or fault, it shall be opened or closed at a uniform speed for not less than 2 seconds. Quick manual opening and closing operations may cause damage to the electric stay bar or controller.

### Set the opening angle of boot lid through multimedia display screen

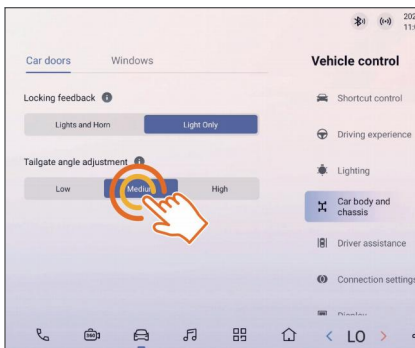

1. Tap  [Vehicle control] - [Car body and chassis] - [Tailgate angle adjustment] in the bottom navigation bar of the

multimedia display screen to adjust the boot lid angle to [Low], [Medium] or [High] as required.

2. According to the actual needs, after tapping the required opening height value of the boot lid on the setting page, the system will provide an audible prompt, indicating that the setting is successful.



### Caution

The opening height of the boot lid in the multimedia display screen is for reference only. Please set the specific height according to the actual operation.

### Anti-pinch protection

When the boot lid opens automatically, if an obstacle is detected, the boot lid will stop opening; when the boot lid closes automatically, if an obstacle is detected, the boot lid will stop closing and return to the preset maximum opening height.



### Warning

Make sure that there is no one nearby when opening or closing the boot lid automatically. When operating the boot lid, do not interfere with its movement in any form unless necessary.

## Seat

### Front seats

#### Manual adjustment of driver seat



1. Backrest angle adjustment handle  
Sit in the seat, lift the handle, and lean forward or press back against the backrest. After adjusting the backrest to the appropriate position, release the handle, and shake back and forth a few times to ensure that the backrest is locked in place.

2. Seat height adjustment handle  
Repeatedly lift or press down the handle to adjust the seat up or down;

3. Seat forward/backward adjustment lever

Lift the pull rod to adjust the seat to move forward and backward. After adjusting to the appropriate position, release the pull rod and make sure that the seat does not move forward or backward.

#### Manual adjustment of front passenger seat



1. Seat forward/backward adjustment lever

2. Backrest angle adjustment handle

The manual adjustment method of the front passenger seat is the same as that of the manual adjustment of the driver seat.

#### Electrically-operated driver seat\*



1. Massage function adjustment button  
Press this button to switch between lumbar support adjustment and massage adjustment. When switching to the massage function, press 3 button to adjust the massage intensity, and press 2 button to select different massage modes (refer to Adjustment of the driver seat through the multimedia display screen\*\*)

for the intensity and mode).

2. Up/Down adjustment button of lumbar support

Press this button to adjust the lumbar support to move up and down. After adjusting to a proper position, release the button.

3. Forward-backward adjustment button of lumbar support

Press this button to adjust the lumbar support to move forward and backward. After adjusting to a proper position, release the button.

4. Backrest angle adjustment button

Push the button forward and backward gently to adjust the seat backrest angle. After adjusting to a proper position, release the button.

5. Seat forward-backward and height adjustment button

Push this button forward and backward to adjust the seat forward and backward; pull the rear end of this button up and down to raise or lower the seat. After adjusting to a proper position, release the button.

### Electric adjustment of front passenger seat\*



1. Seat forward-backward adjustment button

Push the whole button forward and backward gently to adjust the seat forward and backward. After adjusting to a proper position, release the button.

2. Backrest angle adjustment button

Push the whole button forward and backward gently to adjust the seat forward and backward. After adjusting to a proper position, release the button.

### Adjustment of the driver seat through the multimedia display screen\*

Tap [Seat] on the A/C setting interface to enter the seat setting interface.



1. Tap/press and hold to adjust the driver seat backrest angle.

2. Tap/press and hold to adjust the upper and lower positions of the driver seat.

3. Tap/press and hold to adjust the front and rear position of driver seat.

4. Tap the switch to cycle through the ventilation modes in the order of "OFF - High - Medium - Low - OFF".

5. Tap to enter the seat massaging setting interface.

# Operation of Basic Functions

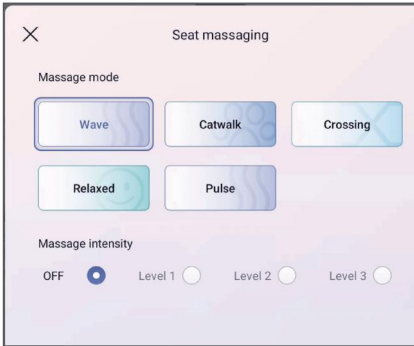

The seat massaging interface includes [Message mode] and [Message intensity]. When the seat massaging function is turned on, the message icon on the seat control interface will be highlighted and the message intensity level will be displayed.



## Caution

- The driver shall not adjust the seat during driving.
- Be careful when adjusting the seat to ensure that it will not hurt other passengers when moving the seat.
- When adjusting the seat, do not put your hands under the seat or near moving parts to avoid injury.
- Do not tilt the seat excessively; otherwise, the waist seat belt may slip over the hip and directly strangle the abdomen, or make the shoulder seat belt touch the neck, which will cause serious injury or even increase the risk of death in case of an accident.
- If the seat adjustment fails through the multimedia display screen, check whether the seat is adjusted in place or stuck by any object.



## Caution

- Please do not place objects under the seat and clean up small objects in the seat sliding rail in time to prevent abnormal phenomena such as jamming during the seat sliding process.
- When a child is in the vehicle, the seat must be adjusted by an adult to prevent the passenger's body from sliding forward due to unfixed cushion or similar objects on the seat and causing accidental injury in case of emergency brake or accident.
- Before driving, please adjust the driver seat to a correct driving position, which can reduce incorrect operation and effectively play the protective function of the seat belt, airbag, headrest and other configurations.

## Rear seat

### Rear seat backrest adjustment and flattening

The rear seat backrest angle cannot be adjusted and can only be folded flat.

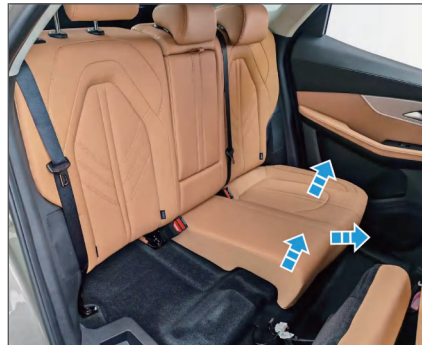

1. Lift the front end of the seat cushion upward with force and pull it forward to the position where it contacts the front seat backrest, and then turn over the seat cushion so that the front end of the seat

cushion faces downward and contacts the floor at an approximately vertical angle to the floor.



2. Pull up the lock catch at the top of the backrest to unlock the seat backrest lock, and then gently fold the seat backrest forward.

### Restoration of rear seat



Push the backrest back to lock it, turn

over the seat cushion, and gently press down the front end of the seat cushion to make it move backward and downward naturally until the rear end of the seat cushion is inserted under the backrest. Then press down the front end of the cushion to lock it into the lock slot.



### Caution

- Do not fold the seat backrest during driving.
- When folding the rear seat backrest, be careful not to catch your hand.
- Do not fold the rear seat backrest when a passenger sits on the rear seat or the luggage is placed on the seat.
- When restoring the rear seat, gently shake the seat and backrest forward and backward to ensure that it is firmly locked in place.
- Check that the seat belts are not twisted or stuck in the seat backrest.

05

### Seat memory\*

Refer to "Personalised memory\*" of "IVI system" for specific operation methods of seat memory function.

### Headrest

#### Front seat headrest



## Operation of Basic Functions

The front seat headrest is integrated and non-adjustable.

### Rear seat headrest



1. To raise the headrest, directly lift the headrest to the desired position until a "click" sound is heard to ensure that the headrest is locked in place.

2. To lower the headrest, press and hold the adjustment switch on the side of the seat headrest, press the headrest downward to the required height, and then release the switch until a "click" sound is heard to ensure that the headrest is locked in place.

### Height of headrest

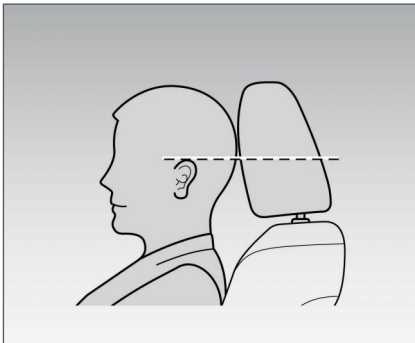

When adjusting the headrest, make sure that the centre of the headrest meets the upper part of the ear, so that the headrest can play the greatest protective role.



### Caution

- The headrest cannot be used when it is in the lowest position. Raise it to this locked position to use it.
- After adjusting the headrest, press the headrest to make sure it is locked firmly.



### Warning

- Do not drive with the headrest removed; otherwise, passengers will be seriously injured in case of an accident.
- The headrest must always be in the locking position. If the headrest is removed or improperly adjusted/installed, it is easy to cause injuries to the driver and passengers in case of emergencies or emergency braking during driving.
- Do not adjust the headrest while driving.

## Steering Wheel

### Steering Wheel Adjustment



1. Steering wheel adjustment handle  
Adjust the steering wheel to a proper position through the following steps:

1. Turn the steering wheel to the straight

forward driving position, i.e. the steering wheel return position.

2. Pull the steering wheel adjustment handle downward to unlock the steering wheel.

3. Adjust the steering wheel up and down, back and forth to a proper position as indicated by the arrow.

4. After adjustment, pull up the steering wheel adjustment handle and confirm that it is locked in place.



## Warning

Do not adjust the steering wheel when the vehicle is running, so as to avoid personal injury or death caused by loss of control of the vehicle.

## Horn



The horn is located in the middle of the steering wheel. Pressing the horn can remind pedestrians and vehicles outside the vehicle. Reasonable use of horns will help to ensure driving safety and reduce the frequency of accidents.

## Steering wheel button (left)

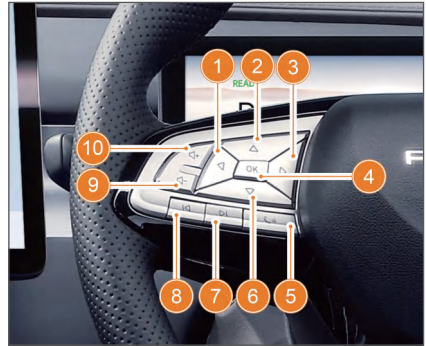

1. Leftward button
2. Up button
3. Rightward button
4. OK button
5. Bluetooth phone button
6. Down button
7. Next track
8. Previous track
9. Volume down button
10. Volume up button

## Steering wheel button (right)

### Type I

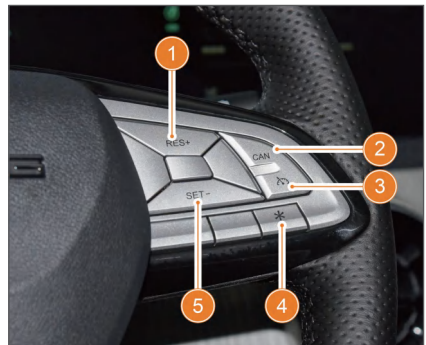

1. Cruise control resume/acceleration button
2. Cruise control pause button
3. Cruise control button
4. Custom button
5. Vehicle speed settings/deceleration button

# Operation of Basic Functions

## Type II

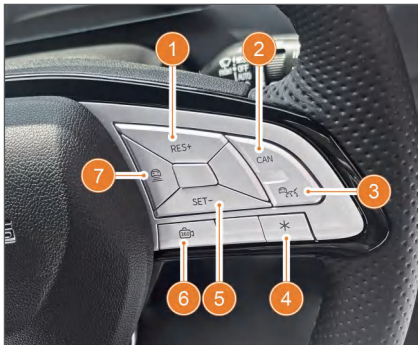

1. Cruise control resume/acceleration button
2. Cruise control pause button
3. Cruise control button
4. Custom button
5. Deceleration button
6. 360° panoramic view button
7. Following distance adjustment button



### Caution

When the multimedia display freezes or crashes, press and hold the custom button on the steering wheel until the screen goes off. The multimedia display will then automatically restart.

## Interior rearview mirror



Hold the right side of the interior rearview mirror and adjust the mirror body up,

down, left and right until the rear view can be fully seen from the mirror surface.



### Caution

Due to the structural limitation of the interior rearview mirror, please adjust the interior rearview mirror gently and slowly to prevent the exterior rearview mirror body from coming off due to over-adjustment.

## Anti-dazzling adjustment of interior rearview mirror



Gently pull the tab at the bottom edge of the interior rearview mirror to switch the mirror reflection status to prevent dazzling. When the strong light from behind shines on the interior rearview mirror, the impact of the strong light on the driver can be reduced.



### Warning

- Do not hang a heavy object on the interior rearview mirror or shake or drag it hard.
- Do not adjust the interior rearview mirror during driving; otherwise, severe injury and death may occur due to the accident resulting from misoperation.

## Exterior rearview mirror

Please keep the rearview mirror clean. Before driving, adjust the rearview mirror to the best viewing angle.

### Electric adjustment of exterior rearview mirror



The left/right switch can be used to select the rearview mirror on the corresponding side for mirror angle adjustment.

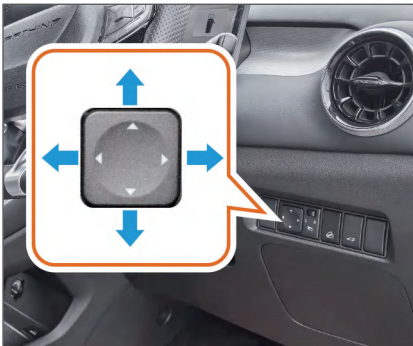

Move the mirror adjustment switch up, down, left and right to adjust the exterior rearview mirror to the best view angle.

### Folding and unfolding exterior rearview mirror

The exterior rearview mirror can be folded and unfolded in any of the following ways:

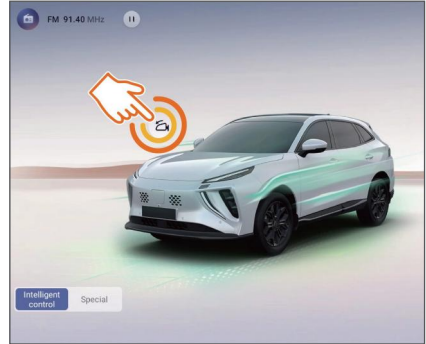

1. In the intelligent control theme interface of the multimedia display screen, tap to fold or unfold the exterior rearview mirror.

2. Tap [Vehicle control] - [Car body and chassis] - [Windows] - [Exterior rearview mirror folding] in the bottom navigation bar of the multimedia display screen to fold or unfold the exterior rearview mirror.

3. For some models, you can tap [Rearview folding] on the 360° panoramic view interface to fold or unfold the exterior rearview mirrors.

### Automatically folding and deploying\*

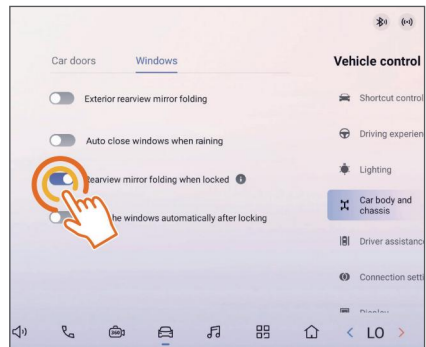



Tap [Vehicle control] - [Car body and chassis]-[Windows] in the bottom navigation bar of the multimedia display screen in turn to enable the function of [Rearview mirror folding when locked].

## Operation of Basic Functions

The four doors are closed. When the vehicle is powered off, press the lock button or unlock button on the smart key. The exterior rearview mirror can be automatically folded or unfolded.

### Heating & defrosting of exterior rearview mirror

After the vehicle is powered on, tap the  on the A/C control panel or tap  on the A/C interface of multimedia display screen to turn on or off the defrosting function, which can remove fog, frost and thin ice from exterior rearview mirrors.



#### Caution

- Before driving, in order to ensure driving safety, it is necessary to ensure that the exterior rearview mirror is reset before adjusting the mirror angle.
- Do not adjust the exterior rearview mirror during driving.
- If the exterior rearview mirrors are not folded or unfolded, it may be that the exterior rearview mirrors are not reset after collision. In this case, manually push the lens forward until a "click" sound is heard, and then fold or unfold the exterior rearview mirrors for two or three times.
- If there is snow on the exterior rearview mirror, please remove the snow before adjusting the exterior rearview mirror to avoid damaging the exterior rearview mirror.

### Power window

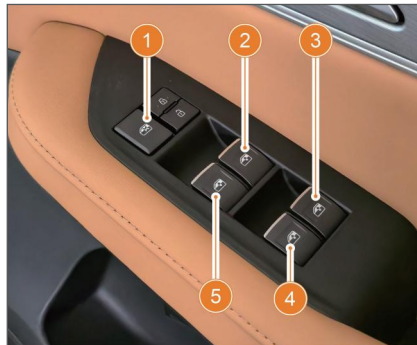

1. Window lock switch
2. Front right window switch
3. Rear right window switch
4. Rear left window switch
5. Front left window switch

### Manual opening/closing of windows

Pull up or press and hold the window switch downward to manually control the window to rise or fall.

### Automatic opening/closing of windows

Pull up or press the window switch downward to the limit position and then release it. The window can automatically rise or fall. If you need to stop halfway, pull up or press this switch again.

### Remotely opening/closing windows

When the start switch is set to "OFF" position and all doors are closed, long press the unlock button on the smart key, and the four windows will descend simultaneously until they are fully opened; when all four doors and the boot lid are closed, long press the lock button on the smart key, and the four windows

will ascend simultaneously until they are fully closed.

## Window lock switch

To prevent children from accidentally opening or closing the window, pressing the window lock switch can disable the operation of the front passenger side window and the rear window. At this time, the window can only be controlled by the driver. If it needs to be restored, press this switch again.

## Window thermal protection

If the window is operated repeatedly in a short time, the motor protection function will be triggered and the power window control switch will fail. To resume window operation, wait for a while and then operate again.

## Auto window closing during rain\*

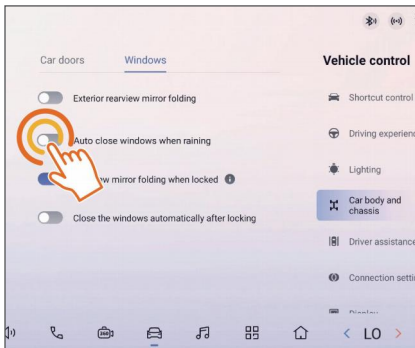

Tap [Vehicle control] - [Car body and chassis] - [Windows] at the bottom navigation bar of the multimedia display screen in turn to enable the function of [Auto close windows when raining]. After the vehicle is powered off and locked, when the rain is sensed, windows will be automatically closed.

## Window anti-pinch protection

During window closing, if an obstacle is encountered, the window will stop closing and move in the opposite direction for a certain distance. The automatic anti-pinch function will also work in case of impact or similar conditions to window obstacles.

### Anti-pinch power window activation conditions

The power window should first complete initialisation learning. When the power window has automatic ascending function, the anti-pinch function is activated.

### Initialisation learning of anti-pinch power window

It is necessary to conduct initialisation learning of the power window with anti-pinch function for normal use.

1. When the vehicle's 12V low-voltage battery is depleted or when the 12V low-voltage battery is disconnected, the window is rising or falling.
2. After the door control module flashes the software.
3. After the window mechanism is replaced, such as replacing parts and components that affect the window lifting stroke, such as regulator, rubber strip, glass, weather strip and guide slot.
4. After the door shield and door control module are replaced.

### Steps of initialisation learning

1. Pull up the window switch and hold it until the window is completely closed, and then hold it for more than 2 seconds.
2. Press and hold the window switch downward until the window is fully opened, and continue to hold it for more

## Operation of Basic Functions

than 2 seconds.

3. Pull up the window switch again until the window is closed.

4. Initialisation learning ends.

The above steps need to be operated in a coherent manner to ensure successful learning. If the power window still cannot work normally after the above operations, please contact a Forthing service station.



### Caution

- When operating the window, make sure that no part of the passenger's body is pinched.
- Do not allow children to operate power windows.
- Do not leave children, incapacitated adults or pets in vehicles with windows closed and locked. Personal injury or death may be caused as the temperature inside the car is too high to open the doors and windows.
- Do not deliberately test the anti-pinch function by pinching any part of the body.
- If an object is clamped when the window is about to be fully closed, the anti-pinch function may not work.

## Sunroof\*

### Panoramic sunroof

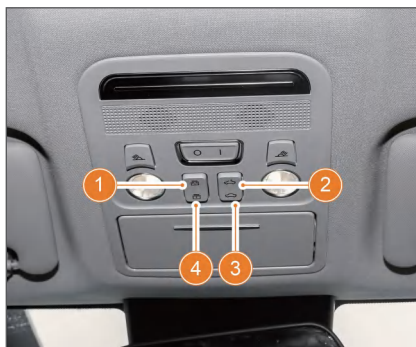

1. Sunshade opening switch
2. Sunroof opening switch
3. Sunroof closing switch
4. Sunshade closing switch

To improve interior light and air circulation, the sunroof and its sunshade can be opened. To operate the sunroof switch, the vehicle must be powered on.

### Sunroof tilting/closing

With the sunroof closed, tap the sunroof opening switch, and the sunroof will tilt and the sunshade will be opened synchronously.

With the sunroof tilted, tap the sunroof closing switch and the sunroof will be closed.

### Sunroof opening/closing

With the sunroof closed, tap the sunroof opening switch, and the sunroof will slide backward and tilt and the sunshade of the sunroof will be opened synchronously. Tap the sunroof opening switch again, and the sunroof will be opened fully by one touch.

With the sunroof open, tap the sunroof closing switch, and the sunroof will be closed by one touch.

During the one-touch opening/closing of sunroof, tap the sunroof control switch again to stop it at the current position.

### Opening/closing of sunshade

Tap the sunshade opening/closing switch to open or close the sunshade. To stop the sunshade, operate any sunshade switch once again.

When the sunroof is open, the sunshade cannot be closed beyond the sunroof opening position (sunshade follow-up function).

### Anti-pinch protection

The sunroof/sunshade has the anti-pinch protection function within 200 mm from full closing. When the sunroof/sunshade touches abnormal resistance or an obstacle in its automatic closing process, it will automatically stop midway and return for a certain distance. This function can prevent personal injury.

### Initialisation

When the sunroof system cannot be closed in place, it can be restored by the following operations: When the sunroof and sunshade are fully closed, press and hold the sunroof closing switch for about 6 to 8 seconds and the sunroof will move back and forth less than 10 mm. Release

the sunroof opening switch for 5 seconds and then press and hold the sunroof closing switch again. The sunroof will automatically open completely first and then close for a round trip. At this time, release the sunroof closing switch and the sunroof initialisation is completed.

### Remote closing of sunroof

When the vehicle is powered off, the sunroof cannot be operated. If the sunroof is open at this time, it can be closed with the smart key lock button.

### Delayed closing

The sunroof can be opened/closed within 30 seconds after the vehicle is powered off.

### Thermal protection of sunroof motor

To prevent abnormal function caused by overheating of the sunroof motor, after the sunroof is operated continuously for 120 s (under normal resistance state), the thermal protection function will be activated and the motor will enter the sleep state and will not work. At this time, the sunroof will not be able to move temporarily. After about 30 seconds of motor cooling, the sunroof can be operated again.



#### Warning

- The remote control function can only be used when the vehicle is within sight and it is confirmed that no passengers are stuck in the sunroof or windows.
- To avoid accidents, do not put your head or other body parts out of the sunroof when it is closing or during driving.



## Warning

- Do not leave children alone in the vehicle, especially when the vehicle is in the ON gear, otherwise accidents may occur due to their misoperation of the sunroof switch.

## Lights

### Exterior lighting

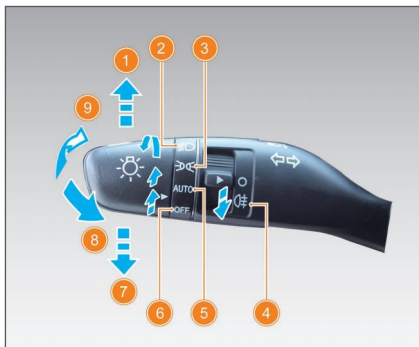

1. Right direction indicator
2. Low beam
3. Position light
4. Rear fog light
5. Automatic lighting
6. Headlight OFF state
7. Left direction indicator
8. High beam flashing
9. High beam

### Direction indicator switch

Pull the light control handle upward or downward, and the right or left direction indicator will flash. After the steering is completed, the handle will return to its original position and the direction indicator will be turned off.

### Switching between high beam and low beam

When the low beam is turned on, push

the light control handle forward to the limit position to turn on the high beam; pull it back to turn off the high beam.

### Position light

When the light switch is in ATUO position and the system detects that the ambient light intensity is dark, press the unlock button on the smart key to unlock the door, and the position light will automatically illuminate; after locking, starting the vehicle or sleeping, the position light will go out.

### Rear fog light

When the low beam is turned on, toggle the adjusting ring to make ► point to the rear fog light, and the rear fog light will be turned on; toggle the adjusting ring again to make ► point to O, and the rear fog light will be turned off.

### Daytime running light

The daytime running light is mainly used in the daytime and can be automatically turned on, so that other drivers can see your vehicle more clearly and ensure driving safety.

### Automatic lighting

When the end of the light control handle is rotated to make ► point to AUTO, the headlights and other exterior lights will be automatically turned on or off according to the ambient brightness.

### Follow Me Home

Turn the light control handle back and forth once within 5 minutes after the vehicle is shut down, and the "Follow Me Home" function will be turned on. At this time, the low beam will be turned on automatically.

After the door is locked for 30 s or the

"Follow Me Home" function is turned on for 5 minutes, the low beam will be automatically turned off.

## Headlight height adjustment

When the vehicle is heavily loaded, the rear part of the vehicle body will sink, so that the low beam will be raised, affecting the driver's sight and causing potential safety hazards. At this time, you should find a safe place to stop the vehicle and then adjust the headlight height.

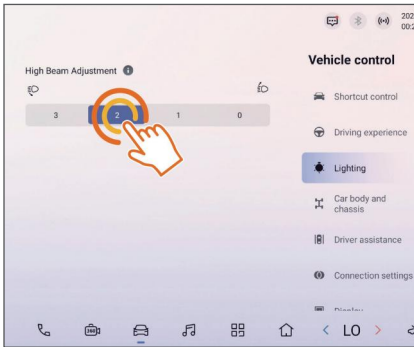

Tap  [Vehicle control] - [Lighting] in the bottom navigation bar of the multimedia display screen, find [High Beam Adjustment], and select different levels of headlight height according to the number of passengers and vehicle load.

## Interior light

### Interior light

The interior lights have the off-delay function.

## Front interior light

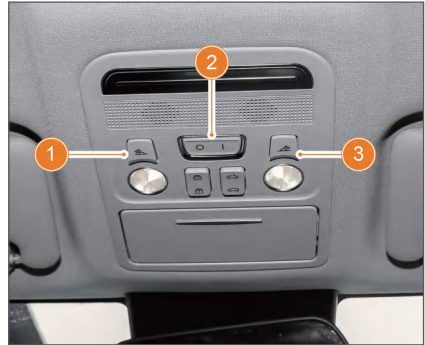

### 1. Front left interior light switch

When the door control switch is parallel to the panel or at the O end, press the switch to light up and press it again to turn off.

### 2. Door control switch

When the switch is at end O, the door control will be turned off.

When the switch is at end I, all interior lights are on.

When the switch is parallel to the panel, the interior lights will light up or go out with the opening and closing of the four doors.

### 3. Front right interior light switch

When the door control switch is parallel to the panel or at the O end, press the switch to light up and press it again to turn off.

# Operation of Basic Functions

## Rear interior light

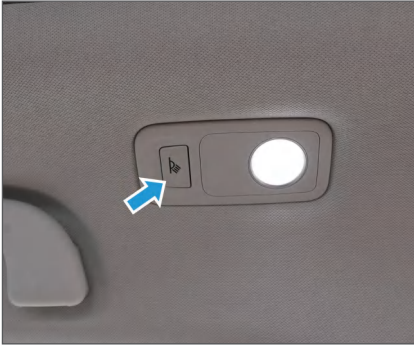

The rear interior light is located next to the rear handle (Vehicle component positions may vary depending on different vehicle configurations). Press the left/right interior light switch to turn on or off the interior light at corresponding side of the rear row.

## Boot light



Open the boot lid, and the boot light will be on automatically. Close the boot lid, and the light will turn off automatically.

## Wiper

### Front manual wiper



### Front automatic wiper\*

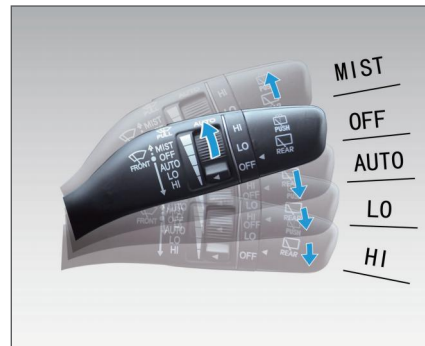

**MIST:** Inching. Pull the wiper control handle upwards to wipe the wiper once, and the handle will automatically return to its original position after release.

**OFF:** Turn off the wiper. When the wiper control handle is at OFF position, stop wiping. This is the default gear.

**INT:** Intermittent wiping. Pull the wiper control handle downward to the INT position, the wiper will wipe intermittently, and the intermittent time can be adjusted by adjusting the ring. From top to bottom, the intermittent time gradually decreases and the wiping speed gradually increases.

**AUTO\*:** Automatic wiping. Pull the wiper

control handle downward to the AUTO position, the wiper will wipe automatically, and the sensitivity can be adjusted by adjusting the ring. From top to bottom, the sensitivity gradually increases and the wiping speed gradually increases.

**LO:** Wipe at low speed. Pull the wiper control handle downward to LO position for low-speed continuous wiping.

**HI:** Wipe at high speed. Pull the wiper control handle downward to HI position for high-speed continuous wiping.



## Caution

When the wiper control handle is turned to AUTO position and the automatic wiping function of wiper is activated, the wiper may wipe under the following conditions, which is normal:

- Areas where the light changes significantly, such as woods and overpasses.
- Foreign object such as leaves, falls on the sensor area.
- Vehicles pass through dusty areas, such as following large vehicles or passing through construction sections.

The following conditions may cause the automatic wiping function to fail:

- Foreign objects are attached to the surface of the rain sensor.
- If other electronic equipment is added or connected to the vehicle, the system function may also be affected during use.

## Front windscreen washer

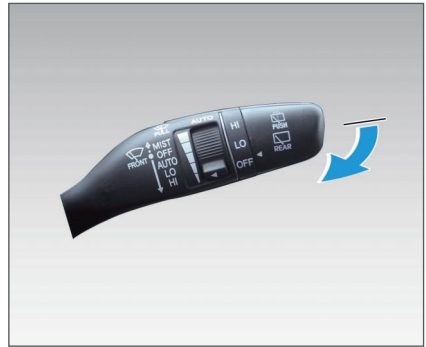

Pull the wiper control handle toward the steering wheel and hold it, and the front windscreen washer starts to spray water, and the front wiper performs low-speed wiping at the same time. Release the wiper control handle, and the wiper stops spraying water and wiping after wiping several times.

05

## Rear wiper

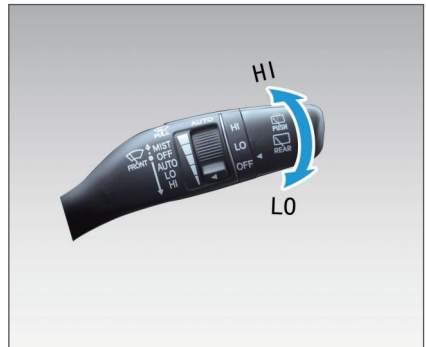

**HI:** High-speed wiping of rear wiper. Turn the rear end of the wiper control handle to the HI position, and the rear wiper performs high-speed wiping.

**LO:** Low-speed wiping of rear wiper. Turn the rear end of the wiper control handle to the LO position, and the rear wiper performs low-speed wiping.

# Operation of Basic Functions

## Rear windscreen washer

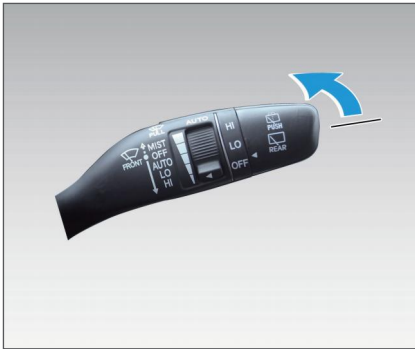

Push and hold the wiper control handle forward, and the rear windscreen washer starts to spray water. At the same time, the rear wiper performs low-speed wiping. Release the wiper control handle to stop spraying water and wiping.



### Caution

- Before using the wiper in winter, please remove the ice and snow on the windscreen first, and make sure that the wiper blade is not frozen on the windscreen.
- Do not use the wiper when the windscreen is dry; otherwise, it may scratch the windscreen and affect the service life of the wiper blade.
- If there is dust or sand on the windscreen, please clean it promptly before using the wiper; otherwise, it may scratch the windscreen and affect the service life of the wiper blade.

## Type-C interface

The Type-C interface can only work after the vehicle is powered on.



The Type-C interface is located in the storage tank at the bottom of the auxiliary dashboard.



### Caution

- The maximum charging power is 60W. Do not insert high-power electrical devices to avoid fire.
- When plugging and unplugging the data cable, keep it in the same direction as the Type-C interface as far as possible. Do not tilt it to avoid damaging the Type-C interface.

## USB interface

The USB interface can only work after the vehicle is powered on.

### USB media source interface at the front of dashboard



The USB media source interface is located in the glove box and used for data transmission, charging, etc.

### Rear USB interface of auxiliary dashboard



The USB interface is located below the rear air outlet of the auxiliary dashboard, which is convenient for rear passengers to use.



#### Caution

- When the USB power interface is not used, cover the dust cover tightly.



#### Caution

- The maximum charging power for the USB interface is 18W. Do not plug in high-current electrical devices to prevent fire hazards.
- Do not insert metal foreign objects into the interface to avoid fire caused by short circuit.
- When plugging and unplugging the USB data cable, try not to tilt it in the same direction as the USB interface, avoiding damaging the USB interface.

## 12V on-board power supply

The 12V on-board power supply can only work after the vehicle is powered on.

05



The 12V on-board power supply is located under the auxiliary dashboard.



#### Caution

- When the 12V on-board power supply is not used, cover the dust cap tightly.
- The maximum output power of the 12V on-board power supply is 120 W. Do not insert high-power electrical appliances to avoid fire.
- Do not allow children to use or contact with the 12V on-board power supply.



### Caution

- Do not allow children to use or touch the 12V on-board power supply, and do not insert metal foreign objects into the power interface to avoid short circuit and fire.
- Do not insert metal foreign objects into the power interface to avoid fire caused by short circuit.

### Wireless charging\*



The wireless charging device is located on the front of the auxiliary dashboard. It can be used to charge portable chargeable devices (such as mobile phones) that support wireless charging.

Before charging, make sure that there is no interference from other objects in the wireless charging area. After the vehicle is powered on, place the portable charging device to be charged in the charging area and determine whether the charging is successful based on the charging status indication of the portable charging device.

After charging is completed, it will automatically stop. If it is necessary to stop charging midway, remove the portable chargeable device being charged from the surface of the wireless

charging device.



### Warning

- Never place items containing metal components together with your phone in the wireless charging sensing area, otherwise they may be heated or damaged and cause safety accidents.
- The driver should not perform wireless charging settings while driving.
- Do not charge your mobile phone alone in the vehicle to avoid safety hazards.
- Before using the mobile phone wireless charging function, make sure that card keys, credit cards or other magnetic items are kept away from the charging area to avoid damage.
- Do not sprinkle water on the front of the auxiliary dashboard, to avoid water entering wireless charging module to cause damage to electronic components.
- Do not place heavy objects in the charging area to avoid damage to the mobile phone wireless charging module.
- The wireless charging function can only be supported for devices that meet the wireless charging protocol.
- The maximum supporting power of wireless charging is 50W.
- The wireless charging device can only support one portable chargeable device for charging at a time.
- When the vehicle runs through bumps, wireless charging may be briefly interrupted.



### Caution

- When using the wireless charging function, please place the device in the centre of the charging area to avoid the device being unable to charge or having low charging efficiency.
- Charging mobile phones with special materials (such as mobile phone cases with metal brackets/metal magnets) or thicker cases may cause charging failure.
- If the mobile phone cannot be charged normally, make sure that there are no foreign objects in the wireless charging area and the mobile phone is in the charging area, or wait for the charging sensing area to cool down before trying again. If it still cannot be charged, please contact a Forthing service station in time.

## Dashcam\*

### Insertion and extraction of memory card



The memory card slot of the dashcam is located on the left side of the dashcam. Please confirm whether there is a memory card in the card slot before the first use.

Pry up the plug on the left side of the dashcam with a straight screwdriver wrapped with a soft cloth to see the rubber plug of the memory card slot. Pull out the rubber plug to insert and pull out the memory card. When inserting the card, please make the text identification side of the memory card face upward. After inserting the card, reinstall the rubber plug and fasten the plug. Support 8G~64G, Class10 and above exFAT format TF cards. It is recommended to format the TF card before use.



### Caution

The vehicle is not equipped with a memory card, which needs to be provided by the user.

05

## Operation of dashcam

### On

After the vehicle is powered on, the dashcam starts working and enters the recording state.

### Close

When the vehicle is powered off, the dashcam will be turned off automatically.

## A/C system

### A/C control panel

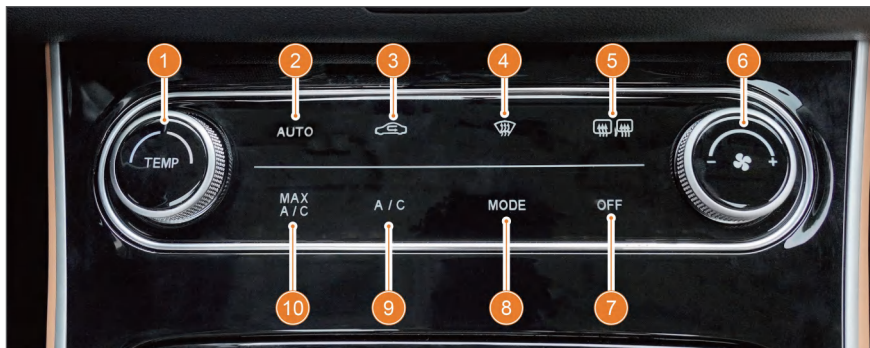

### A/C interface on the multimedia display screen

Tap the A/C temperature value or slide up **< LO >** icon in the bottom navigation bar of the multimedia display screen to enter the A/C setting interface.



- |  |  |
|--|--|
| 1. A/C temperature adjustment knob/ slider                 | 7. A/C system (OFF) button               |
| 2. AUTO button   | 8. Blowing mode adjustment (MODE) button |
| 3. Circulation mode switch button                          | 9. A/C button                            |
| 4. Front defrosting button                                 | 10. Maximum cooling button               |
| 5. Rear defrosting/exterior rearview mirror heating button | 11. A/C setting button                   |
| 6. A/C air volume adjustment knob/slider                   |  |

### Turning on and off A/C

Tap the A/C system (OFF) button to turn on or off the A/C.

### Turning on and off the refrigeration function

Tap the A/C button to turn on or off the refrigeration function.

### AUTO button

Tap AUTO button, and the A/C system will enter the full-automatic state from the non-automatic state, and the A/C system will automatically adjust the interior temperature.

### Adjust the temperature

Rotate the A/C temperature adjustment knob, or slide the temperature value slider up and down on the A/C interface to select the appropriate temperature level.

### Adjust the air volume

Rotate the A/C air volume adjustment knob, or slide the air volume level slider left and right on the A/C interface to select the appropriate air volume level.

### Air outlet mode selection

Press the blowing mode adjustment (MODE) button or select the required blowing mode icon on the A/C interface to select the blowing mode: air-to-head, air-to-head/air-to-footwell, air-to-footwell, air-to-footwell/defrosting mode.

### Maximum cooling function

Tap the maximum cooling button to enter the maximum cooling mode, with the largest air volume and the lowest temperature.

### Front windscreen defogging

Press the front defrosting button to turn on or off the front windscreen defrosting/defogging function to remove fog or frost on the glass.

### Rear windscreen/external rearview mirror defogging

Press the rear defrosting/external rearview mirror heating button to remove fog, frost or thin ice on the rear windscreen and exterior rearview mirrors. If it is not turned off manually, this function will automatically turn off after 10 to 20 minutes.

### Circulation mode

Tap the circulation mode switch button to switch between recirculation/fresh air modes. It is recommended to select the recirculation mode when passing through areas with lots of smoke and dust.

# Operation of Basic Functions

## A/C settings

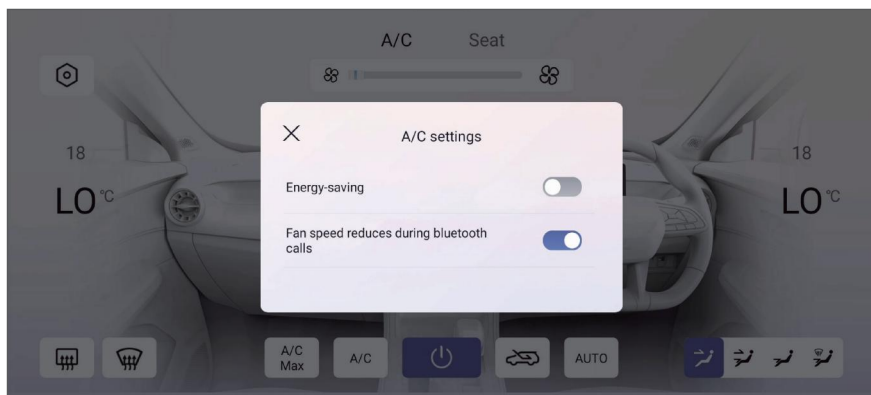

Tap the A/C setting button to turn on or off [Energy-saving] and [Fan speed reduces during bluetooth calls].

### **A/C energy saving**

After the function is turned on, the power consumption of the A/C can be reduced. The temperature drops by 5°C when the A/C works in heating mode and rises by 3°C when the A/C works in cooling mode. In ventilation mode, the temperature remains unchanged.

### **Bluetooth reduces air volume**

After the function is turned on, when a Bluetooth phone is connected, the air volume of the A/C will be automatically adjusted: if the current air volume is greater than level 3, it will be reduced to level 3; if the air volume is at level 1, 2 or 3, it will remain unchanged to ensure call quality.

## Position of air outlet

### Front air outlet

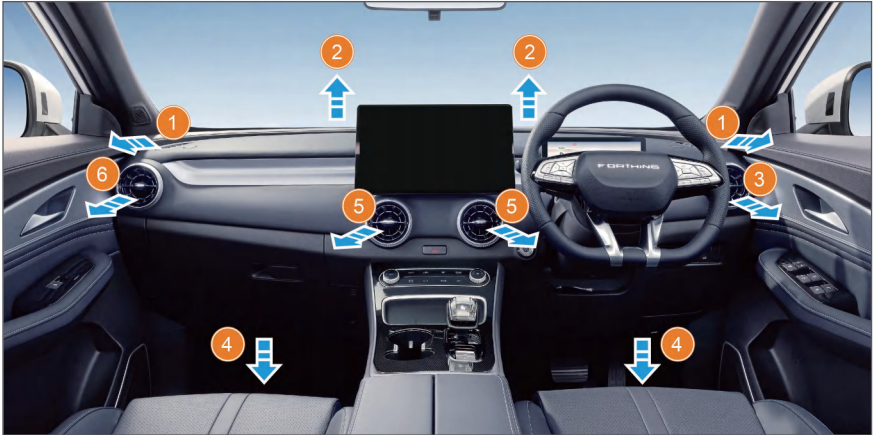

1. Windscreen side defogging air outlet
2. Front windscreen defogging air outlet
3. Right air outlet

4. Front footwell air outlet
5. Central air outlet
6. Left air outlet

05

### Rear air outlet

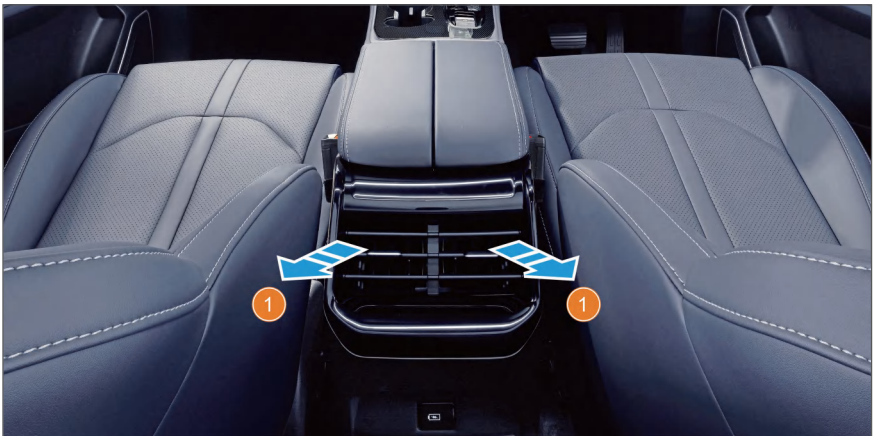

1. Rear-row middle air outlet

## Operation of Basic Functions

### Adjustment of airflow and direction



Turn the air outlet switch knob clockwise to close the air outlet, and counterclockwise to open the air outlet. The air direction can be changed by moving the grille in the middle of the air outlet up and down, left and right.

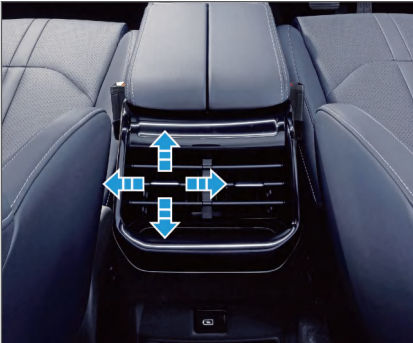

The air direction can be changed by moving the grille in the middle of the air outlet up and down, left and right.

<b>Notes to user</b> .....	<b>86</b>	Connection settings .....	103
<b>Homepage</b> .....	<b>87</b>	Display .....	104
Top status bar .....	87	Sound .....	105
Scene and function interface display area .....	88	Vehicle Status.....	106
Bottom navigation bar.....	89	Factory default.....	107
<b>Drop-down Shortcut Menu</b> .....	<b>90</b>	<b>Energy center</b> .....	<b>107</b>
<b>Standby interface</b> .....	<b>91</b>	<b>Vehicle information</b> .....	<b>108</b>
<b>System Apps</b> .....	<b>92</b>	Mileage energy consumption .....	108
<b>Local media</b> .....	<b>93</b>	Personalized memory* .....	108
Bluetooth music.....	93	Message center .....	109
USB music .....	93	<b>Phone - car interconnection</b> .....	<b>109</b>
<b>Radio</b> .....	<b>94</b>	CarPlay Function Overview .....	109
<b>DAB</b> .....	<b>95</b>	CarPlay connection operation .....	110
<b>Bluetooth calls</b> .....	<b>96</b>	AndroidAuto function overview .....	112
Recent calls .....	97	AndroidAuto connection operation.....	113
Contacts .....	97		
Dialing keyboard .....	97		
<b>Vehicle control</b> .....	<b>98</b>		
Shortcut control .....	98		
Driving experience.....	99		
Lighting .....	100		
Car body and chassis .....	100		
Driver assistance* .....	101		

### Notes to user

1. When using the IVI system (hereinafter referred to as "system"), please carefully read the relevant operating instructions. If the system is damaged due to failure to follow the operating instructions, you will not be eligible for warranty service.
2. Different vehicle configurations and system version updates may result in slightly different operating instructions. Please refer to the actual vehicle.
3. Do not operate the multimedia display screen when the vehicle is running; otherwise, there may be an accident, causing personal injury or death.
4. When using this system, the driver must comply with relevant laws and regulations. The vehicle shall be parked in a safe place before operation, such as entering or changing the destination.
5. In accordance with relevant laws and regulations, the system will not display some functions once a certain speed is reached to ensure your driving safety.
6. If the operation is too frequent, the system may take some time to react. Please be patient and do not repeat the operation.
7. If the system is abnormal, please do not repair it yourself. Please contact a Forthing service station for maintenance in time.
8. When the vehicle is not started, do not use the system for a long time to avoid using up the 12V low-voltage battery.
9. Do not touch, rub or knock the multimedia display screen with sharp objects, and do not splash liquid on it, as this may cause damage to the screen.
10. Do not apply metal film to the surface of the front windscreen, as this may cause certain network functions to fail.
11. In remote areas, mountainous areas, tunnels, or underground parking lots with weak network signals, the use of network functions may be affected. After the vehicle leaves these areas, network signals will automatically recover.

## Homepage

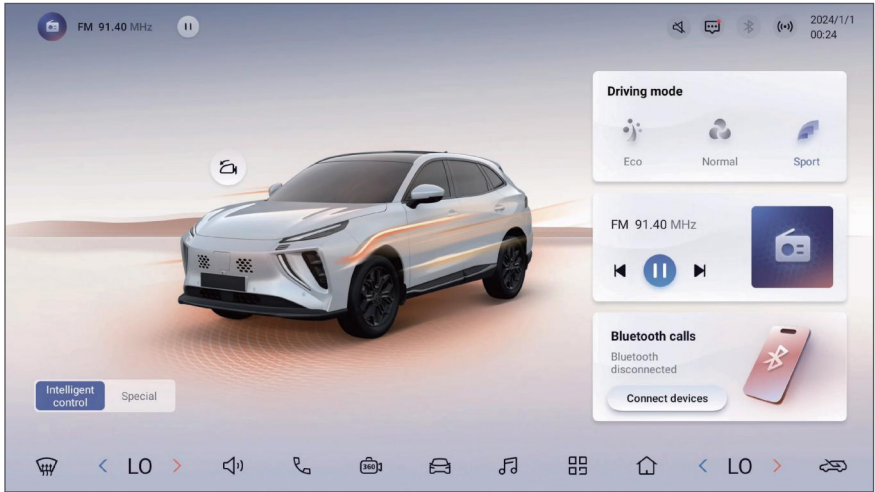

## Top status bar



Icon	Function description
	Intelligent recommendation area: status and controls can be displayed when multimedia or phone is turned on; multimedia information includes media information and play/pause buttons
	The system is muted, and it will not be displayed in non-mute state
	Show unread messages
	It is displayed only when the USB flash disk is identified to be inserted. There are two states: normal and abnormal (the USB flash disk is damaged/data cannot be read or written). Tap to enter the USB music interface
	Including: open unconnected, open connected, and close 3 states. Tap the icon to open the Bluetooth shortcut operation pop-up window, including Bluetooth switch, list of connectable devices and go to Bluetooth setting shortcut button
or	Wi-Fi/hotspot status display: When Wi-Fi is turned on, the Wi-Fi icon is displayed; when hotspot is turned on, the hotspot icon is displayed. When both Wi-Fi and hotspot are turned off, the default Wi-Fi off status icon is displayed

# IVI System

Icon	Function description
2024/1/1 00:24	Show date and time

## Scene and function interface display area

Tap   to switch between intelligent control theme and special theme.



Intelligent control theme: With a car model as the background, it supports driving mode switching and custom cards (multimedia controls, Bluetooth phones, etc.).

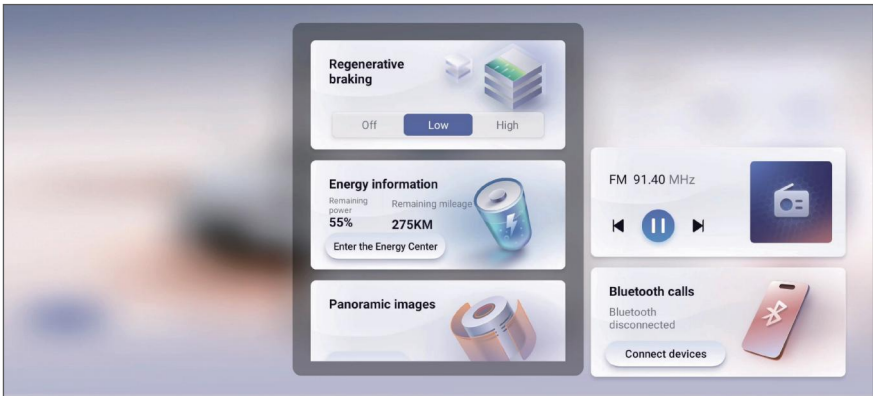



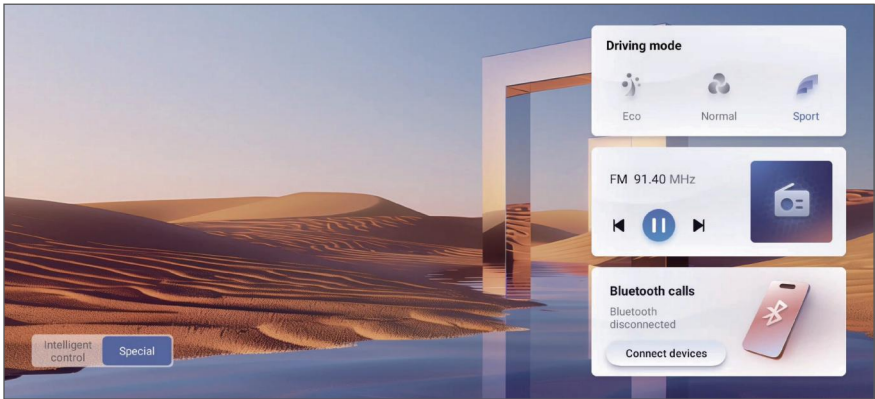



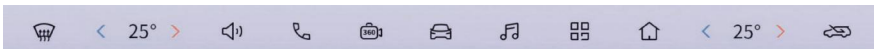

Custom card: Tap the card to enter the corresponding function page, and long press any card to activate the custom setting function.



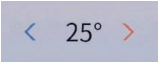

Exclusive theme: custom wallpaper, support driving mode switching, custom cards (music card, Bluetooth phone and other functions).

## Bottom navigation bar







Icon	Function description
	Turn on/off the front windscreen defrosting/defogging function
	The temperature display is synchronized with the A/C interface, and the left and right sides are linked. Each time you tap < / >, it can decrease or increase by 1 degree; tap or slide up in this area to enter the A/C control interface
	Quickly adjust the system volume and Bluetooth phone volume
	If Bluetooth is not connected, tap to enter the Bluetooth setting interface; if Bluetooth is connected, tap to enter the recent call interface
	Enter the Panoramic images interface (equipped for some models)
	Enter the Vehicle control interface
	Enter the Local media interface

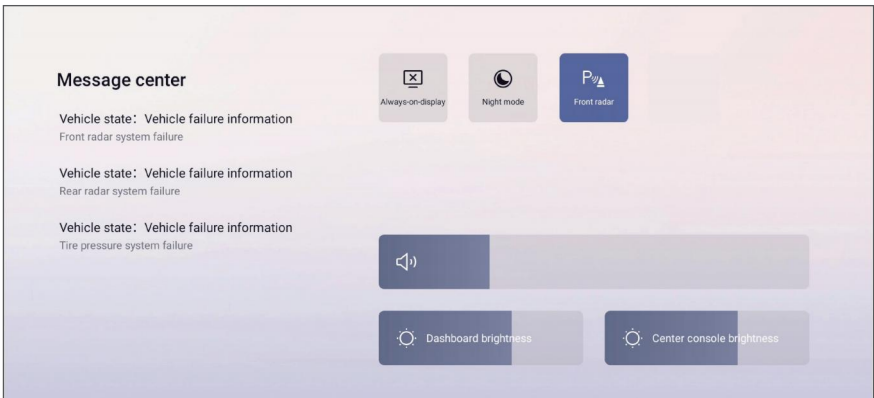

Icon	Function description
	You can enter the System Apps interface, long press any application icon, drag it to the original function button in the navigation area and release it to complete the icon replacement
	Back to homepage
	Switch recirculation mode

## Drop-down Shortcut Menu

Slide down at the top of the multimedia display screen to bring up the drop-down shortcut menu. For different vehicle configurations, the functions displayed in the drop-down shortcut menu may be different. Please refer to the actual vehicle for details.



Icon	Function description
	The Always-on-display interface can be entered/exited
	Night and day modes can be switched
	Front radar can be turned on/off (equipped for some models)
	Adjustable system volume

Icon	Function description
 Dashboard brightness	The instrument display brightness can be adjusted
 Center console brightness	The central control panel brightness can be adjusted
 Message center Vehicle state: Vehicle failure information The pressure sensor status Vehicle state: Vehicle failure information Road safety status	Display vehicle condition information

## Standby interface









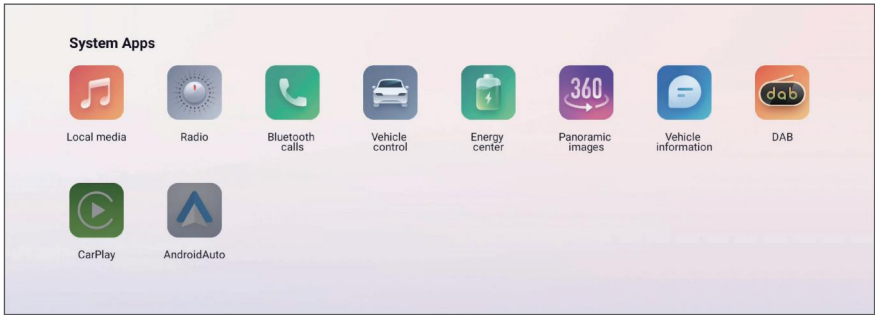

Tap [Always-on-display] in the drop-down shortcut menu or press the custom button on the right side of the steering wheel (you need to set [Steering button user definition] to [Standby]) to enter the standby interface.



## System Apps

Tap the navigation bar at the bottom of the multimedia display screen to  enter the System Apps interface.



Icon	Function description	Icon	Function description
	Tap to enter the Local media interface		Tap to enter the Panoramic images interface, which will not be displayed when there is no panoramic configuration
	Tap to enter the Radio interface		Click to enter the Vehicle information interface
	Tap to enter the Bluetooth calls interface		Tap to enter the DAB interface
	Tap to enter the Vehicle control interface		When CarPlay is connected, tap to enter CarPlay. The background will be highlighted when activated
	Tap to enter the Energy centre interface		When AndroidAuto is connected, tap to enter AndroidAuto. The background will be highlighted when it is activated

## Local media

Tap the navigation bar at the bottom of the multimedia display screen  or Local media in System Apps to enter the Local media interface, which includes: Bluetooth music, USB music and USB videos.

### Bluetooth music





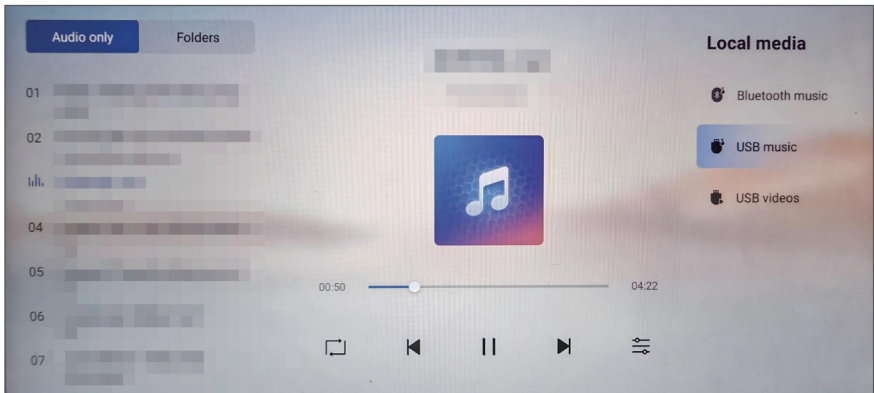

Icon	Function description	Icon	Function description
	Play previous track		Play next track
	Pause/Play		Open the sound effect setting interface

06

### USB music



# IVI System

Icon	Function description	Icon	Function description
	Play previous track		Pause/Play
	Play next track		Switch recirculation mode
	Open the sound effect setting interface	/	/

## Radio

Tap Radio in System Apps on the multimedia display screen to enter the Radio interface and switch between FM/AM.

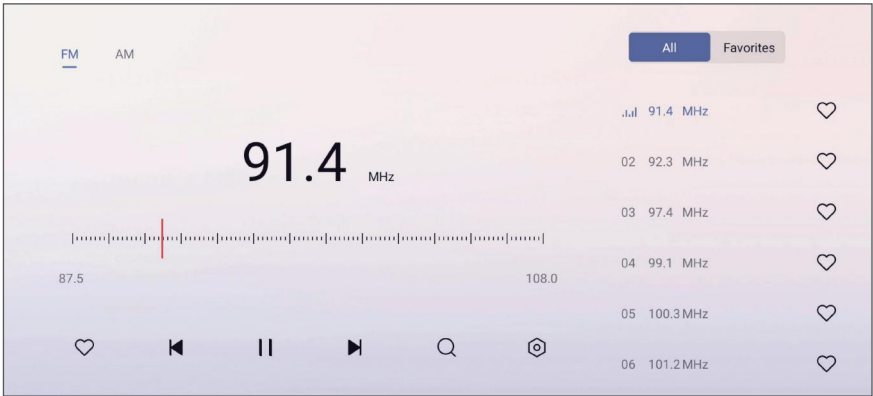

Icon	Function description	Icon	Function description
	Enter the previous one		Add/remove radio stations to/from Favourites.
	Pause/Play		Search radio stations
	Go to the next station		Open the RDS setting interface (not available under AM interface)
	Show list	/	/

## DAB

Tap DAB of System Apps on the multimedia display screen to enter the digital radio interface. The radio can listen to stations in the frequency band specified by DAB.

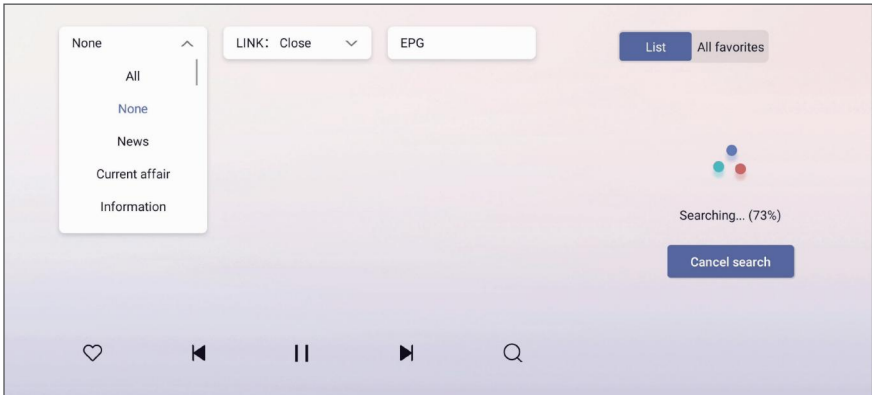

Icon	Function description	Icon	Function description
	Select different DAB broadcast content (all types are displayed by default for the first scan)		When the current receiving channel signal is poor, it can automatically search and switch to the same channel or similar programme channels with better signals
	Open the programme menu		Play the previous radio station
	Pause/Play		Play the next station
	Add/remove radio stations to/from Favourites.		Search radio stations

## Bluetooth calls

Tap the navigation bar at the bottom of the multimedia display screen  or the Bluetooth calls in System Apps to enter the Bluetooth calls interface, which includes: Recent calls, Contacts and Dialing keyboard.

After the Bluetooth device is connected, the system will pop up a prompt asking whether to synchronise contacts. After confirmation, the system will initiate a request for synchronisation of address book and call records. If the mobile phone responds normally, when entering the Bluetooth phone interface, the contact interface will display a loading animation, and the call record and address book will be automatically updated after synchronisation is completed; if the mobile phone fails to respond, the call record interface and address book will be displayed as empty. The system will automatically perform synchronisation when the Bluetooth connection is successful and the mobile phone call ends.

Tap the , the system will also pop up a prompt whether to synchronise. After confirmation, initiate a request for synchronisation of address books and call records.

When Bluetooth is connected, the system will automatically identify the device type and authority:

When the device is not a mobile phone, or it is a mobile phone but calls and address book synchronisation permissions are prohibited, the address book and call records will display "Bluetooth device not connected", and there will be no response when tapping the dial button;

When the device is a mobile phone and only address book synchronisation is prohibited and call permissions are allowed, the address book and call records will display "Contact not synchronised". Tap the dial pad to use it normally.

During Bluetooth information synchronisation: the function buttons on the left can be operated normally; when switching to other interfaces, synchronisation will continue in the background; displayed address books and call records can be tapped normally, and synchronisation is still completed in the background after tapping.

## Recent calls

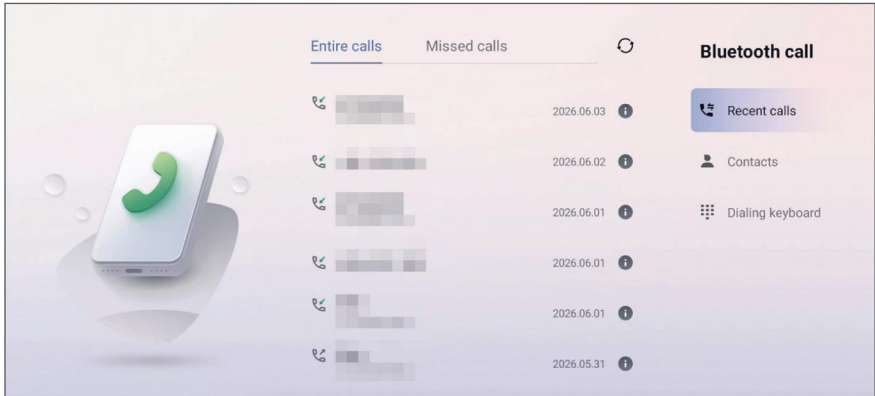

Entire calls: Display a list of all calls.

Missed calls: Display a list of missed calls.

: Sync contacts.

: Display contact details.

## Contacts

Display contact name, contact number (if the contact number is empty, the number will not be displayed, only the contact name will be displayed), and contact avatar (if none, the default avatar will be displayed).

06

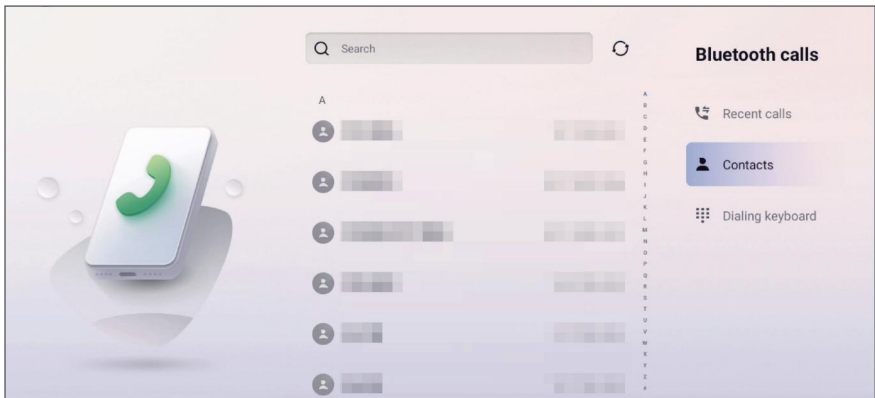

: Sync contacts.

: Enter keywords for searching.

## Dialing keyboard

After the Bluetooth phone is successfully connected, tap on the Dialing keyboard to enter the dialing interface. The interface will display the number to be dialed, the associated contact person and the dialing keyboard.

# IVI System

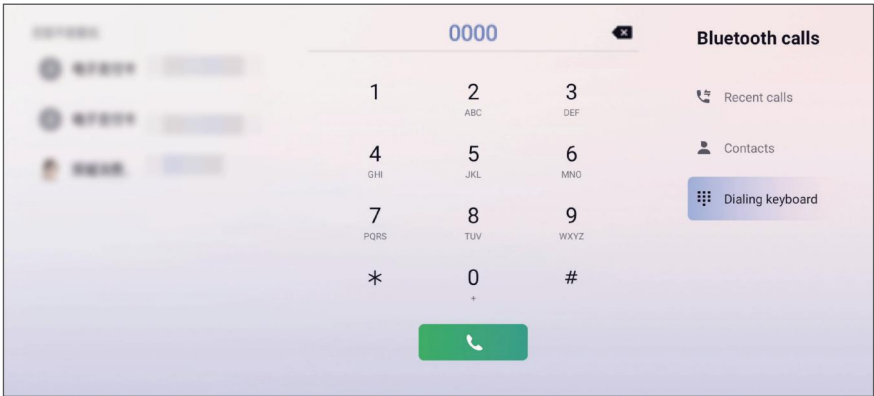

The left side of the dialing interface can be searched according to the content of the number box on the right: if the number starts with 0 or 1, perform a digital search; if it starts with other numbers, perform a pinyin search. The search range is limited to the mobile phone address book; if there is no content in the number box or no matching search results, the interface will display the default illustration. After dialling, tap  to make a call.

## Vehicle control

The Vehicle control interface can be accessed in the following ways:

- Tap the car model picture on the intelligent control theme interface.
- Tap  on the bottom navigation bar of the multimedia display screen.
- Tap the non-button area of the custom card on the homepage to enter the corresponding control interface.

## Shortcut control

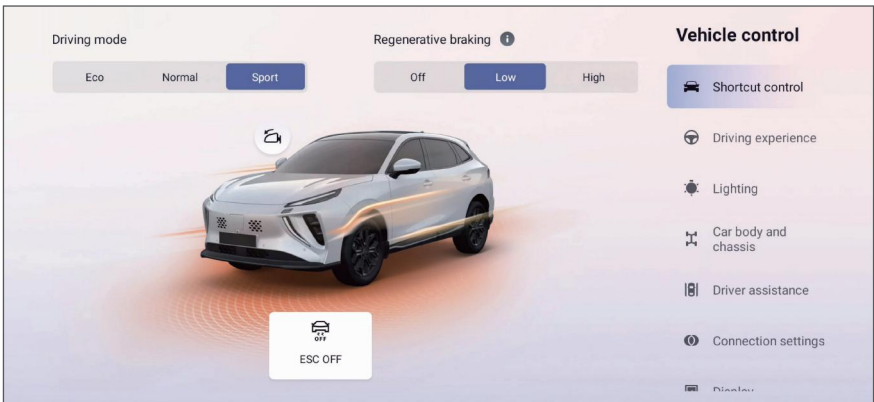

Driving mode: Different driving modes can be selected, including Eco, Normal and Sport.

Regenerative braking: The coasting energy recovery level can be selected, including Off, Low and High.

 : Tap to fold/unfold the exterior rearview mirror.

 : Tap to turn on/off the ESC OFF function.

## Driving experience

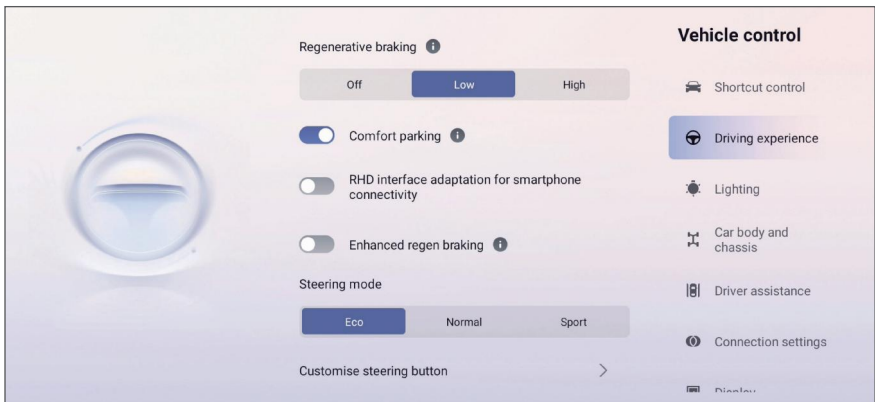
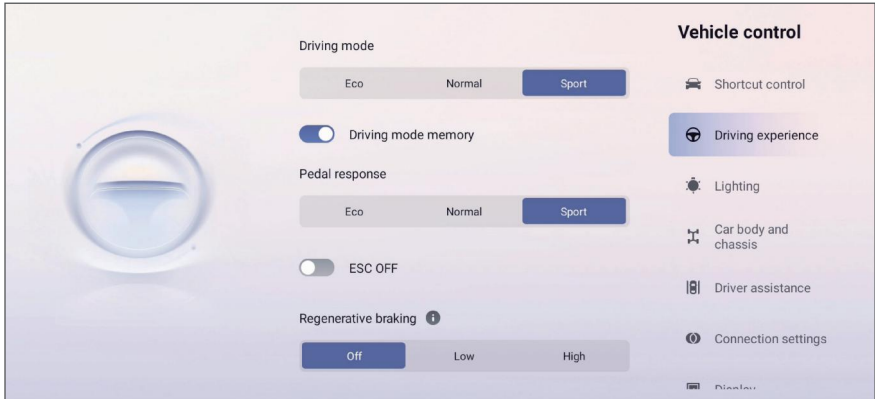

**Driving mode:** Different driving modes can be selected, including Eco, Normal and Sport.

**Driving mode memory:** Tap it to turn on/off the driving mode memory.

**Pedal response:** Different brake pedal feeling levels can be selected, including Eco, Normal and Sport.

**ESC OFF:** Tap to turn on/off the ESC function.

**Regenerative braking:** Different coasting energy recovery levels can be selected, including Off, Low and High.

**Comfort parking:** Tap to turn on/off Comfort parking.

**RHD interface adaptation for smartphone connectivity:** Tap to turn on/off the CarPlay right-hand drive driving habit function.

**Enhanced regen braking:** Tap to turn on/off the enhanced regen braking.

**Steering mode:** Different steering feel levels can be selected, including Eco, Normal

and Sport.

Customise steering button: Tap to enter the custom setting interface, where you can choose Standby, Mute, Panoramic image\*, Low-speed driving sound, AC ON, Interior & exterior circulation, Return to Homepage.

## Lighting

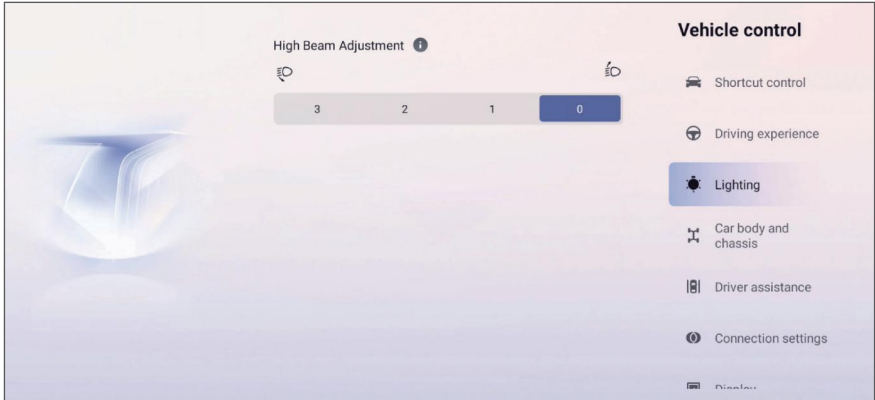

High Beam Adjustment: You can select different High Beam Adjustment states, including: 0, 1, 2, 3.

## Car body and chassis

This interface includes Car doors and Windows.

### Car doors

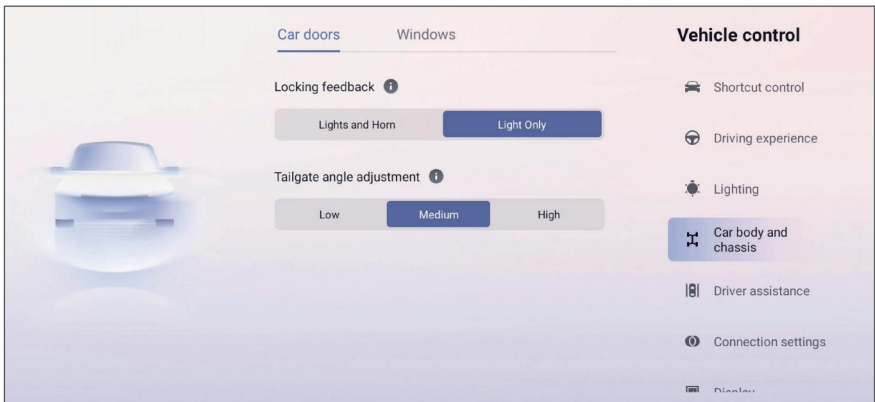

Locking feedback: Different locking feedback modes can be selected, including: Lights and Horn, Light Only.

Tailgate angle adjustment\*: Different tailgate angle adjustment modes can be selected, including Low, Medium and High.

## Windows

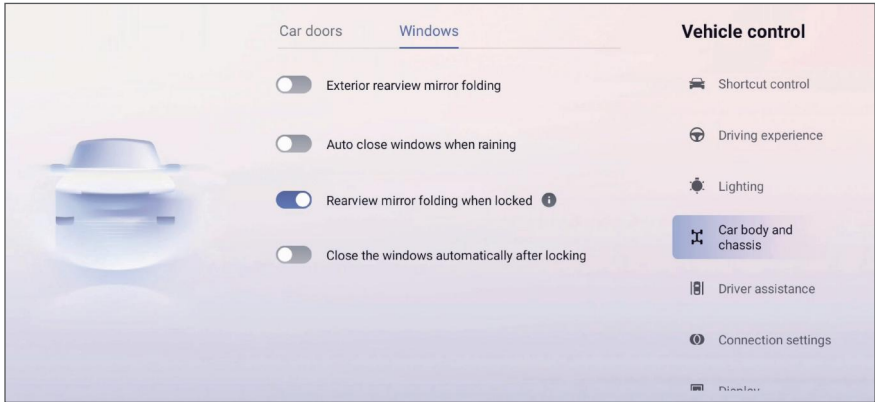

Exterior rearview mirror folding: It can be turned on/off.

Auto close windows when raining\*: To open/close auto close windows when raining.

Rearview mirror folding when locked\*: The rear-view mirror folding when locked can be turned on/off.

Close the windows automatically after locking: It can be turned on/off.

## Driver assistance\*

This interface includes Forward assistance and Lateral assistance.

## Forward assistance

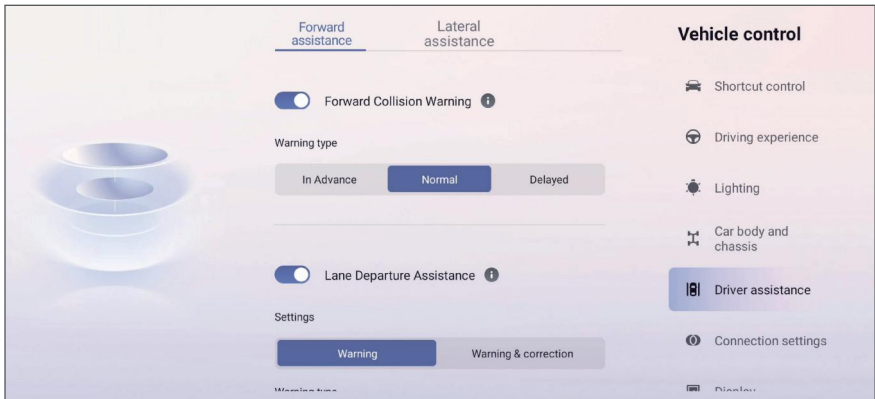

Forward Collision Warning: It can be turned on/off. After it is turned on, different warning type can be selected, including In Advance, Normal and Delayed.

**Lane Departure Assistance:** You can turn on/off Lane Departure Assistance. After turning it on, you can choose different settings, including: Warning, Warning & correction.

**Intelligent high beam control:** It can be turned on/off.

## Lateral assistance

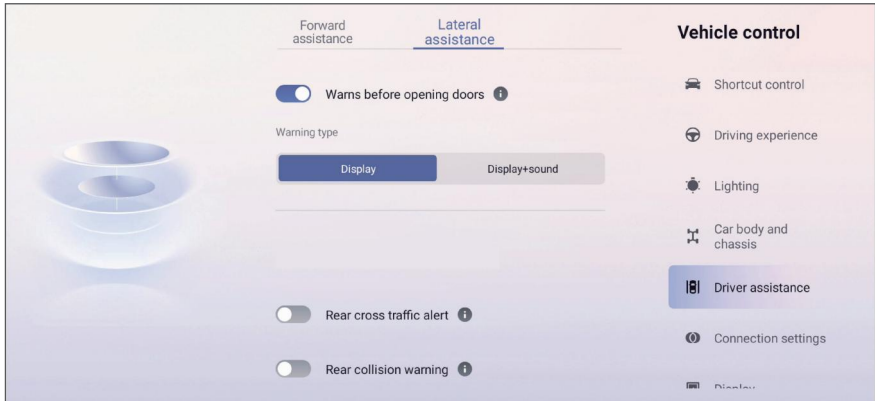
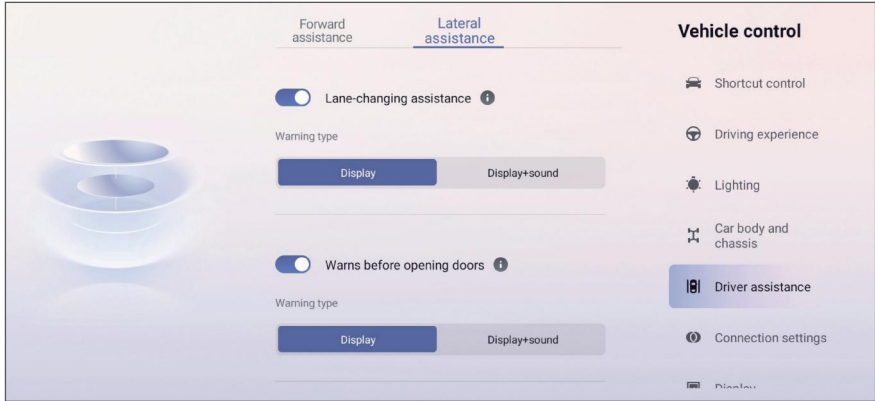

**Lane-changing assistance:** Lane-changing assistance can be turned on/off. After turning it on, you can choose different warning type, including: Display, Display + sound.

**Warns before opening doors:** Warns before opening doors can be turned on/off. After turning it on, different warning type can be selected, including: Display, Display + sound.

**Rear cross traffic alert:** Rear cross traffic alert can be turned on/off.

**Rear collision warning:** Rear collision warning can be turned on/off.

## Connection settings

This interface includes WiFi, Hotspot and Bluetooth.

### WiFi

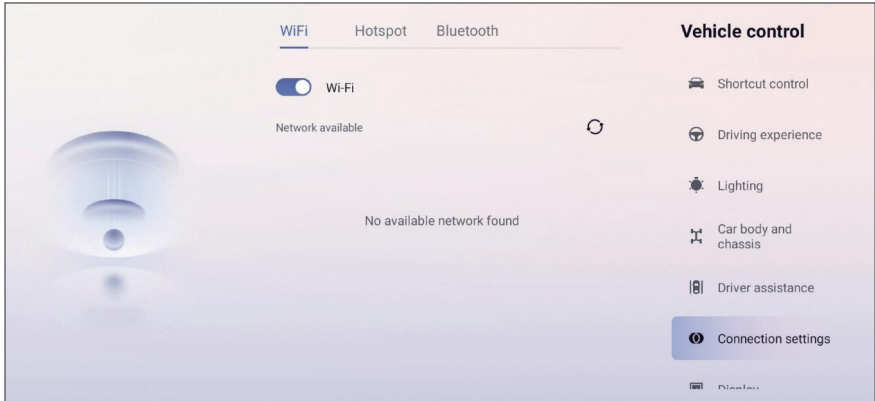

WiFi: You can turn on/off WiFi. After turning it off, it disconnects from the device and does not display the list of connected networks and available networks. The WiFi switch and the Hotspot switch are mutually exclusive and cannot be turned on at the same time.

When connecting to Wi-Fi, a mobile phone that supports 2.4G and 5G frequency bands is required. In the list of available networks, tap [To connect] to manually access the wireless network. Tap  to update the list of networks that can be connected.

### Hotspot

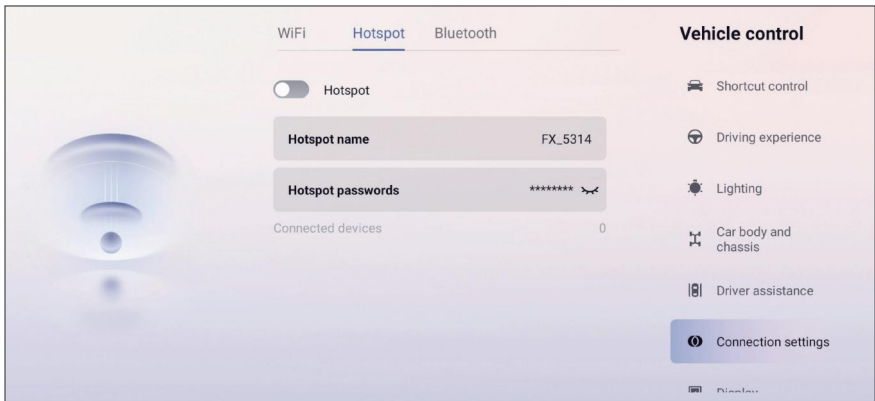

Hotspot: You can turn on/off Hotspot. After turning it off, it will be disconnected from other devices and the list of connected devices will not be displayed.

The hotspot name is a random number by default. Tap to customise the name. The name length is limited to 16 characters and supports uppercase and lowercase letters, numbers and standard ASCII symbols.

# IVI System

The hotspot password supports user customisation and can be edited when the hotspot is turned on or off. Tap the hotspot password to enter the password setting pop-up window. The password supports numbers, uppercase and lowercase letters and standard ASCII punctuation marks, with a length of not less than 8 digits. The hotspot password defaults to an 8-digit random number.

## Bluetooth

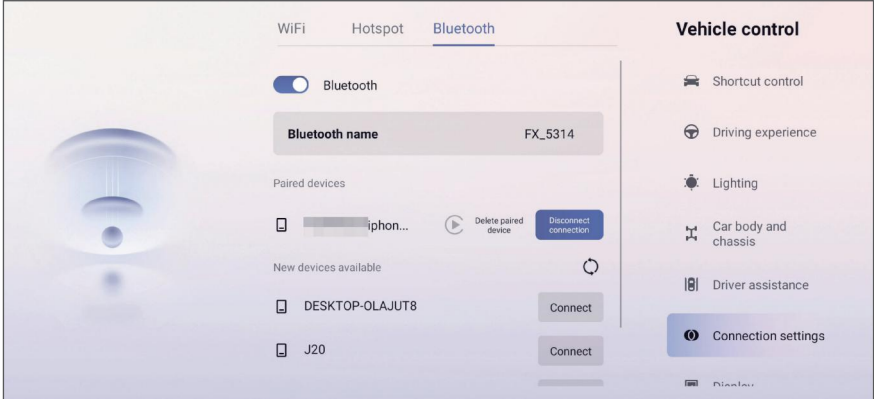

Bluetooth: You can turn on/off Bluetooth. After turning it off, you will be disconnected from other devices and the list of connected devices will not be displayed.

The Bluetooth name is a random number by default. When Bluetooth is turned on, tap to customise the name. The name length is limited to 16 characters and supports uppercase and lowercase letters, numbers and standard ASCII symbols.

Tap Connect, the system will initiate a connection request to the corresponding device, and a pop-up window will prompt you to confirm the connection. If the connection fails, a pop-up window will prompt that the connection failed.

## Display

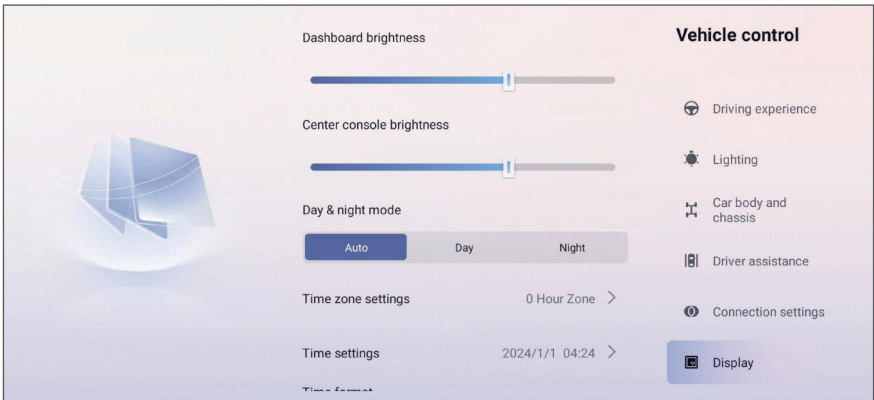

Dashboard brightness: The instrument brightness range is 0 to 20 levels, and the

status bar can be slid or tapped.

Center console brightness: The multimedia display screen brightness range is 0 to 20 levels, and the status bar can be slid or tapped.

Day & night mode: Different Day & night modes can be chosen, including Auto, Day and Night. The default is Auto mode. Select Day or Night, and the brightness of the multimedia display screen will remain constant (when the brightness is not adjusted).

Time zone settings: The default is 0 time zone, which can be selected according to the local time zone.

Time settings: The system time can be set.

Language settings: The default is English, and different languages can be selected, including: Chinese, Traditional Chinese, English, Thai, Indonesian, Malay.

Wallpaper settings: Tap to enter the wallpaper setting pop-up window interface. Default is the built-in wallpaper of the system, and Self-defined is the picture in the external storage device (USB flash drive).

## Sound

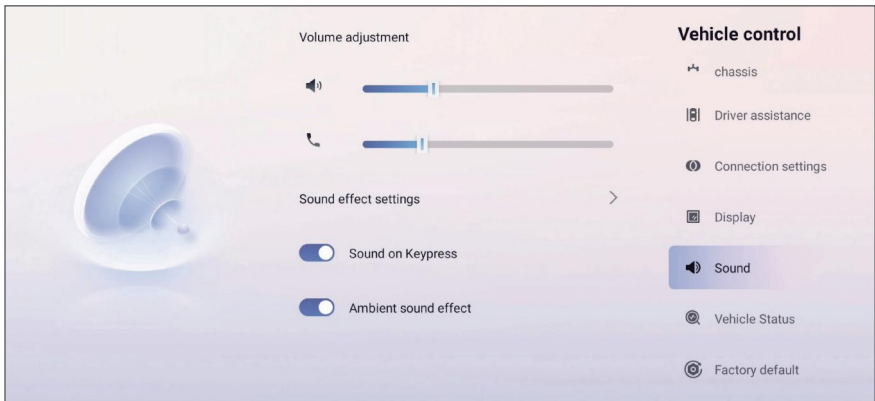

Volume adjustment:

**System volume setting:** The adjustment range is 0~39, the initial value is 10, and the system is muted when the volume is 0.

**Bluetooth phone volume setting:** the adjustment range is 1 to 39, and the initial value is 10. After setting any volume, it is memorised and saved.



**Sound effect settings:** You can select different sound effects in the pop-up sound effect setting interface.

**Sound on Keypress:** The sound on keypress can be turned on/off. After turning it on, the screen tapping sound effect, USB device insertion prompt sound effect, IVI system pop-up window prompt sound effect and other functions are normal; after turning it off, the above prompt sound effect function is disabled.

**Ambient sound effect:** The ambient sound effect can be turned on/off.

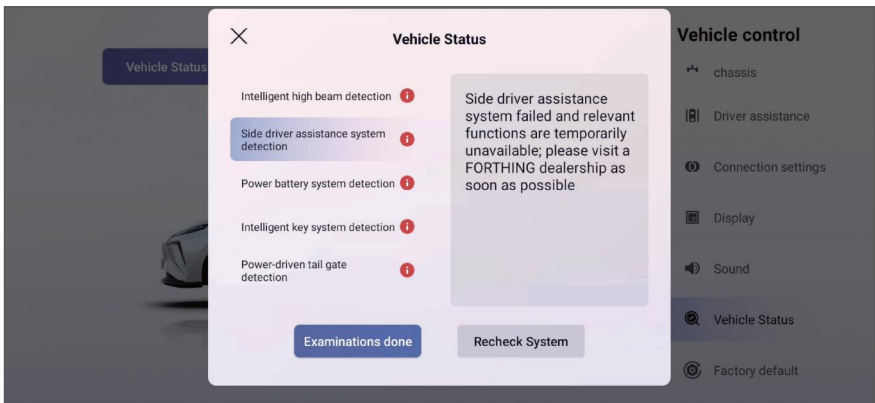
## Vehicle Status



Tap [Vehicle Status] to pop up the vehicle detection interface and perform fault detection. The pop-up window interface displays the system and status of the completed detection one by one. After all tests are completed, jump to the test report interface. It includes information list, Examinations done and Recheck System. The mark  after the information list indicates that the system is normal. To  indicate that there is a fault in the system, tap [] or [Examinations done] to exit the pop-up window interface and return to the inspection and maintenance interface; tap [Recheck System] to start a new round of inspection.

## Factory default



Tap [Reset to factory default], and a pop-up window will appear to confirm whether to restore the factory settings. Tap [Confirm] to enter the interface of clearing the factory reset settings, where all user-defined setting items can be restored to the factory default state.

## Energy center

The energy centre includes functions such as energy information display, energy recovery level setting, charging limit setting and range standard setting.

Energy centre can be accessed by:

- Tap on the Energy centre of System Apps.
- When the vehicle starts charging, it will automatically jump to this interface.



1. It indicates the remaining power of the vehicle.
2. Regenerative braking: You can choose Off, Low or High.
3. Charging limit: The upper charging limit can be set from 80%~ 100%, with one level every 5%. When the set value is lower than the current battery pack SOC, the

setting fails and a reset prompt is given.

4. Different range standards can be selected, including CLTC or WLTC.

5. Tap to turn on/off Heating while driving\*.

## Vehicle information

Tap the Vehicle information of System Apps on the multimedia display screen to enter the Vehicle information interface, including: Mileage energy consumption, Personalised memory\* and Message centre.

### Mileage energy consumption

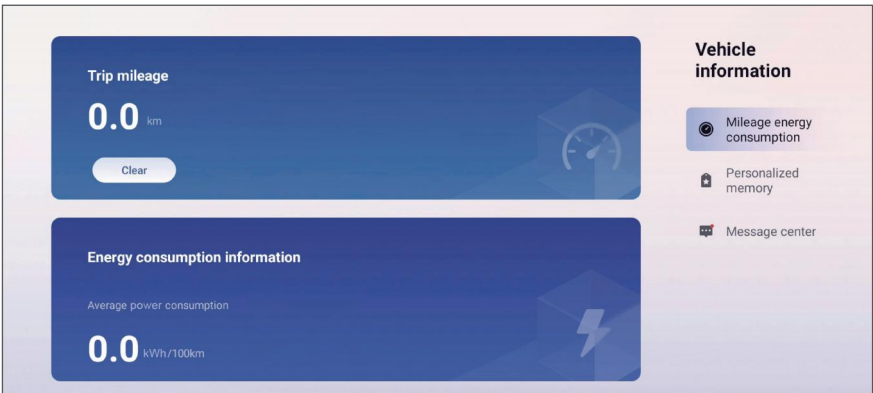

**Trip mileage:** Display the trip mileage. Tap [Clear] to display a confirmation pop-up window, and tap [Confirm] to clear the trip mileage.

**Energy consumption information:** Display Average power consumption.

### Personalized memory\*

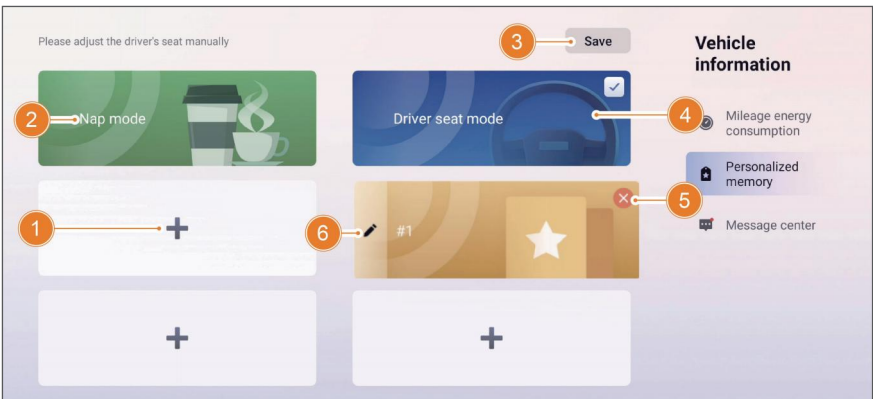

1. Tap to add a memory card.

2. Nap mode: default seat front and rear 75%, backrest 70%, up and down 50%; tap [Save] after editing to overwrite the default value.

3. Tap to overwrite the data of the currently used personalised memory slot, and a pop-up prompt will appear.
4. Driver seat mode: default seat front and rear 30%, backrest 35%, up and down 50%; tap [Save] after editing to overwrite the default value.
5. Tap to delete the memory. The currently used slot and fixed slot cannot be deleted ([x] is not displayed).
6. Tap to rename the personalised memory.

## Message center

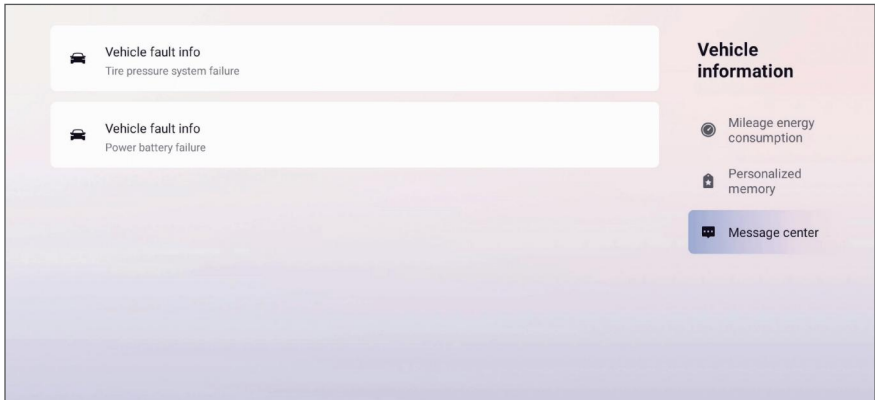

06

Display vehicle-related information, tap to view specific information.

## Phone - car interconnection

### CarPlay Function Overview

CarPlay is an intelligent in-vehicle system developed by Apple, which can integrate iPhone functions into the vehicle's central control and provide core driving assistance functions such as navigation, calls, and music.

#### Main functions and features

Navigation and maps: Support Apple Maps real-time navigation, integrated traffic updates.

Communication and information: voice calls, answering calls, support Siri to read and send text messages.

Entertainment function: Direct access to audio applications such as Apple Music and Spotify, supporting music and podcast streaming services.

Third-party application extension: Open interface supports taxi and messaging applications.



## Caution

For detailed introduction of CarPlay functions, please log in to Apple's official website to view the relevant user manual. The reference website is: [Use CarPlay with your iPhone - Apple Support \(China\)](#)

## CarPlay connection operation

### Wireless connection

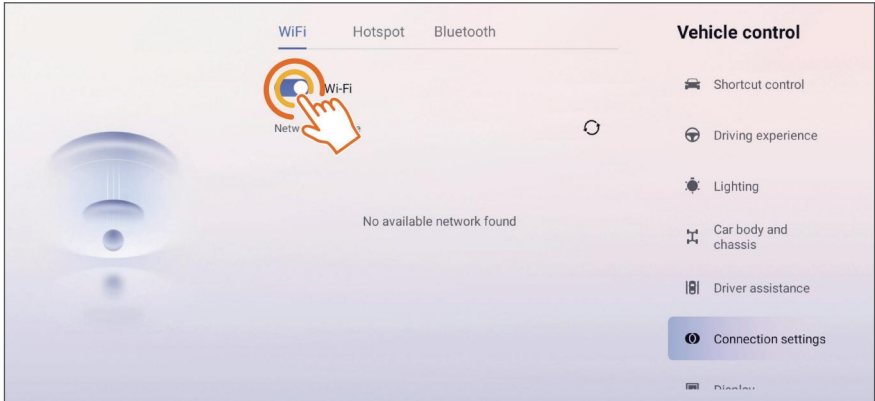

1. To connect CarPlay for the first time, tap [Vehicle control]-[Connection settings] in the bottom navigation bar of the multimedia display screen, turn off the Wi-Fi function in the [WiFi] setting interface, and tap [Hotspot] and [Bluetooth] in sequence to turn on Hotspot and Bluetooth.

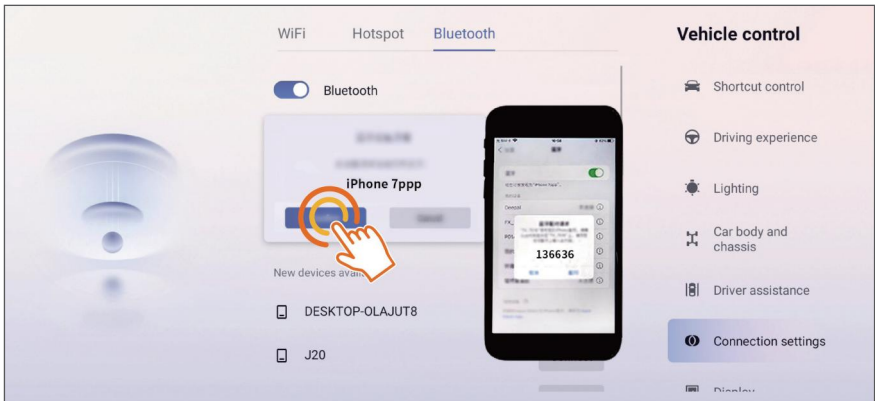



2. In the [Bluetooth] interface, search for the Bluetooth name of the iPhone that needs to be connected to CarPlay in the list and pair with it (you can also use the mobile phone to match the Bluetooth on the IVI side), complete the Bluetooth pairing according to the operation process shown in the figure above, and choose to use the

CarPlay vehicle system on the mobile phone side and the IVI side respectively.

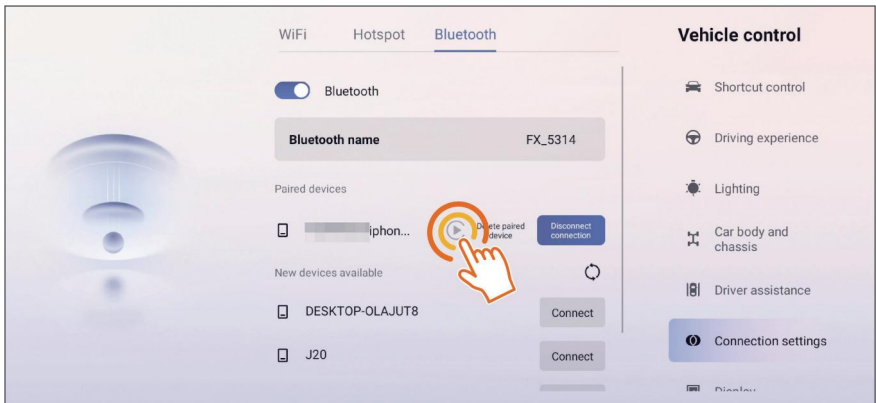

3. After the above operations are correct and the first connection is successful, it will automatically enter the CarPlay interface. Tapping the back icon  on this interface will exit to the homepage of multimedia display screen.



4. If the CarPlay have already been connected, tap the  after the Bluetooth name of the paired iPhone in the [Bluetooth] interface and wait a few seconds for the connection to be successful. Please wait patiently after tapping once, and do not tap repeatedly to avoid abnormal CarPlay data and affecting the CarPlay connection.

### Wired connection

Just connect the IVI to the mobile phone directly with a data cable, and it will be connected automatically. The CarPlay interface will also be automatically entered after the first wired connection.

## Disconnect

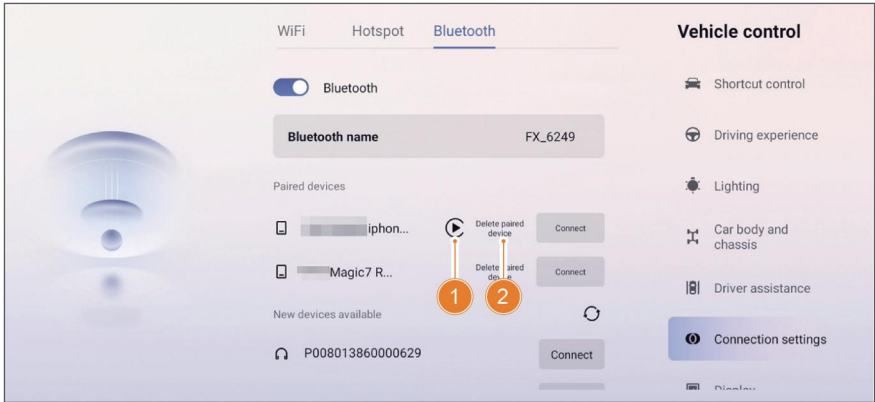

When connecting wirelessly, disconnect by turning off the WiFi function on your mobile phone or in the [Bluetooth] interface of the multimedia display screen:

1. Tap to disconnect CarPlay and keep the connection record.
2. Tap to delete the connection record and disconnect CarPlay.

When connected by wire, unplug the connecting data cable to disconnect.

## AndroidAuto function overview

AndroidAuto is an in-vehicle infotainment system developed by Google that allows users to connect their Android phones to the vehicle's infotainment system and access the phone's applications, navigation, media and communication functions through the vehicle's display.

### Main functions and features

Navigation function: Support Google Maps and Waze, real-time traffic conditions.

Media control: supports music applications such as Spotify and Pandora.

Calls and messages: voice answering calls, sending text messages, message reading.

Security and privacy: data encryption, permission management, restriction of manual operation during driving.

Third-party application support: open API, support music and messaging applications.





### Caution

For detailed introduction of AndroidAuto functions, please log in to the official website to view the relevant user manual. The reference website is: <https://developer.android.google.cn/training/cars/platforms/android-auto?hl=zh-cn>

## AndroidAuto connection operation

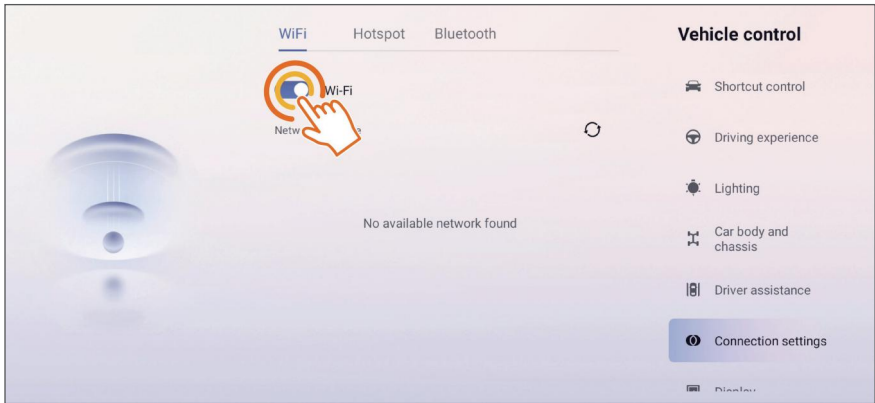
### Wireless connection



1. To connect AndroidAuto for the first time, tap  [Vehicle control]-[Connection settings] in the bottom navigation bar of the multimedia display screen, turn off the Wi-Fi function in the [WiFi] setting interface, and tap [Hotspot] and [Bluetooth] in sequence to turn on Hotspot and Bluetooth.

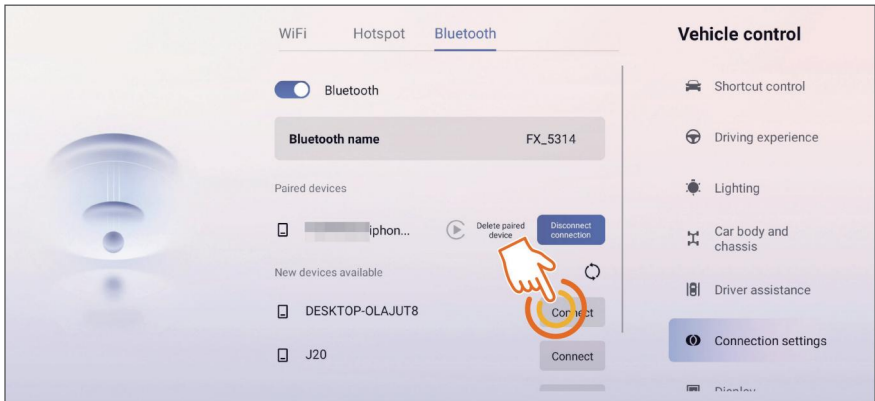

2. In the [Bluetooth] interface, search the list for the Bluetooth name of the Android phone that needs to be connected to AndroidAuto and pair it with it (you can also use your mobile phone to match the Bluetooth on the IVI side). If the wireless AndroidAuto switch on the mobile phone is turned on, there will be a first pop-up window after connecting to Bluetooth. Tap Confirm to enter the AndroidAuto interface.

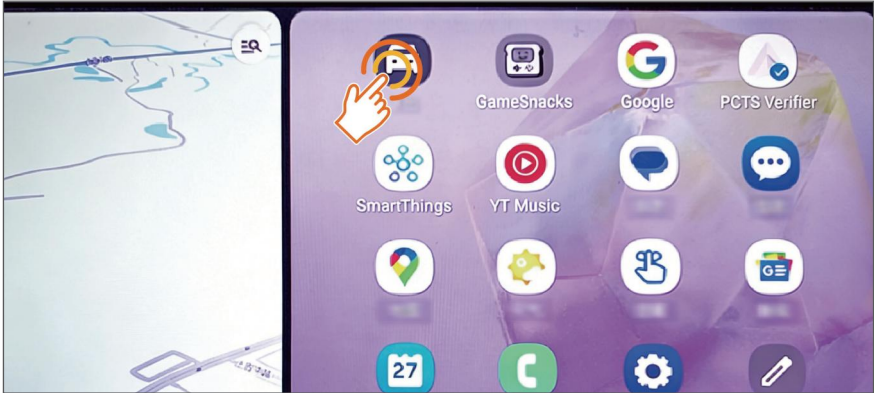

3. After the above operations are correct and the first connection is successful, it will automatically enter the AndroidAuto interface. Tapping the back icon  on this interface will return to the homepage of multimedia display screen.

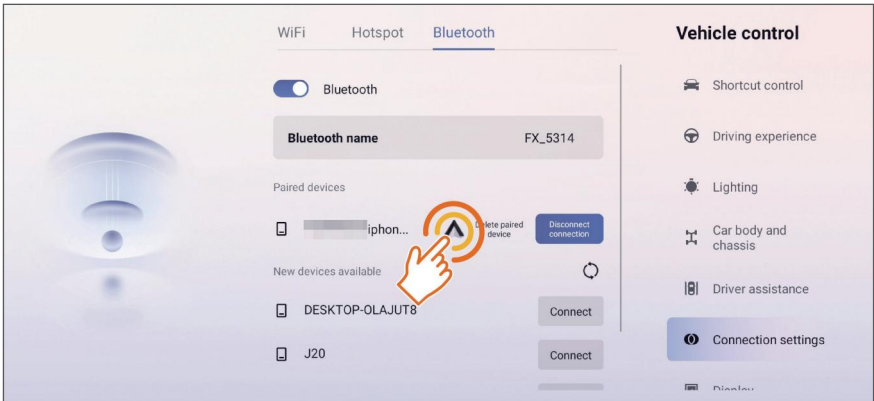

4. If the AndroidAuto have already been connected, tap the  after the Bluetooth name of the paired Android phone in the [Bluetooth] interface and wait for the connection to be successful.

### Wired connection

AndroidAuto connection does not distinguish between the first and subsequent connections. Directly connect the IVI to the mobile phone with a data cable and jump to the AndroidAuto interface without a confirmation pop-up window.

## Disconnect

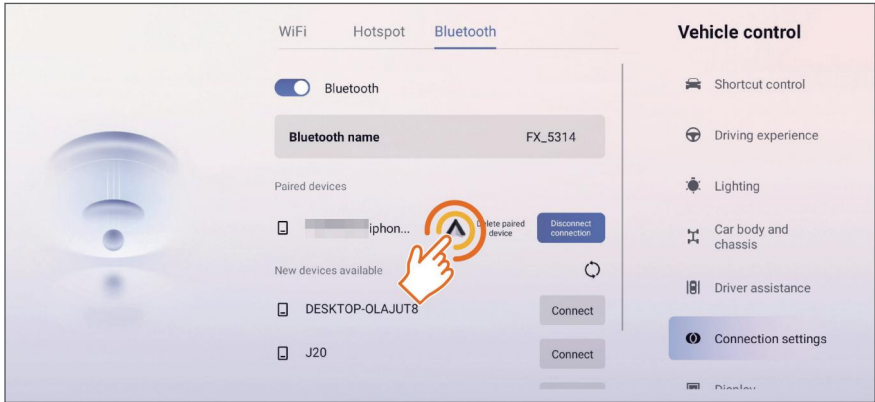

When connecting wirelessly, disconnect by turning on the flight mode on the mobile phone or tapping ▲ on the [Bluetooth] interface of the multimedia display screen. When connected by wire, unplug the connecting data cable to disconnect.

## Convenience Device

### **Storage device ..... 117**

Door storage box ..... 117

Storage of auxiliary

dashboard..... 117

Central armrest box ..... 118

Glove box ..... 118

Magazine pocket of seat back  
..... 118

Cup holder ..... 118

Glasses case ..... 119

### **Other devices..... 119**

Sun visor..... 119

Vanity mirror..... 119

Top handle ..... 120

Hooks ..... 120

Retractable curtain \* ..... 120

### Storage device

#### Door storage box



The interior trim panels of the front and rear doors are provided with door storage boxes for storing water cups and other articles.

#### Storage of auxiliary dashboard

##### Upper storage slot of auxiliary dashboard



The upper part of the auxiliary dashboard is designed with a storage slot for mobile phones, etc.

##### Lower storage slot of auxiliary dashboard



The lower part of the auxiliary dashboard is designed with a storage slot for placing some small items, such as mobile phones and keys.

##### Rear storage slot of auxiliary dashboard



The rear storage slot of auxiliary dashboard is located below the rear air outlet, where mobile phones and other items can be placed.

## Convenience Device

### Central armrest box



Press the front lock catch of the central armrest box, and the left and right armrests will open automatically.



The central storage box is designed with an air vent, and the air vent can be opened or closed by turning the switch.

### Glove box



The glove box is located on the left

side of the dashboard and can store the documents and data delivered with the vehicle. Pull the glove box handle outward to open it, and push it forward to close it.

### Magazine pocket of seat back



The magazine pocket is located on the back of the front seat for placing small items such as plastic bags and tissues.

### Cup holder

#### Front passenger cup holder



## Rear passenger cup holder



The rear-row central armrest is provided with a cup holder, and the strap can be pulled downward to roll out the cup holder.

The cup holder can hold tea cups, beverage bottles and other items for easy use during travel.



### Caution

When the vehicle is running, do not place an open beverage cup on the cup holder. Otherwise, the hot drink in the cup splashed out from the cup will scald the driver and passengers or may damage the vehicle and electrical equipment in the vehicle.

## Glasses case



Press the glasses case to open it slowly, and push it back to close.

## Other devices

### Sun visor



Turn the sun visor downward to block the front sunlight. To block the strong light on the side, disengage the left/right support rod from the clip, and then turn the sun visor to the side.

### Vanity mirror



If you need to use a vanity mirror, flip down the sun visor and push the cover plate to use it. Some models are equipped with fill-in lights.

## Convenience Device

### Top handle



Handles are provided on the front passenger side and both sides of the rear row for passengers to use under special circumstances.

### Hooks

#### Dashboard hook



A hook is designed on the right side of the glove box for hanging light items such as cups. Press the groove to open it, and press the convex rib to close it.

### Side wall hook



Hooks are provided on the left and right B-pillars for passengers to use.



#### Caution

- The maximum load capacity of the hook is 3 kg. Do not hang overweight objects.
- Do not hang hangers or other hard objects on the side wall hooks. When the side curtain airbag system deploys, these items may be ejected and cause injuries to passengers.

### Retractable curtain \*

#### Installation and removal



1. Press both ends of the retractable curtain toward the middle and retract it, and then clamp it on the fixing slot of the vehicle. After installation, shake it to

check whether it is installed in place.

2. The removal steps are reverse to the installation steps.

### Deployment and retraction



1. Pull the handle of the retractable curtain and fit the clips on both sides into the corresponding slots of the side wall to unfold the retractable curtain.

2. Retract the step and follow the deployment step in the reverse direction.



#### Caution

The retractable curtain is a decorative component, which can cover the trunk. To ensure your safety, do not place anything on it.

### **Starting the vehicle ..... 124**

Vehicle power-on/power-off ....  
..... 124

Start the vehicle power  
system ..... 124

Vehicle maintenance and  
software updates ..... 125

Start failure of vehicle ..... 125

Smart key low battery start ....  
..... 125

### **Shifting operation..... 125**

Gears introduction ..... 126

Driving operation ..... 126

Driving mode ..... 127

### **Energy recovery ..... 127**

Coasting energy recovery 127

Braking energy recovery. 128

### **Parking brake..... 128**

Electronic Parking Brake  
(EPB) ..... 128

AUTO HOLD..... 129

### **Traction control system**

#### **(TCS)..... 130**

#### **Brake assist system ..... 130**

Brake Assist (BA)..... 130

Brake priority ..... 130

Anti-lock brake system (ABS)  
..... 130

Electronic brake distribution

(EBD)..... 131

Electronic stability control  
(ESC) system ..... 131

Suggestions for proper use of  
the braking system ..... 132

Hill Hold Control (HHC) .. 132

Hill Descent Control (HDC) ....  
..... 133

Brake booster ..... 133

Brake pedal feeling  
adjustment..... 133

Comfort Stop System (CST)  
..... 134

### **Electric Power Steering**

#### **(EPS)..... 135**

#### **Suggestions for driving 135**

Safety Driving Notice ..... 135

Driving at night..... 135

Driving Through Water.... 136

Long-distance driving ..... 136

Driving on rainy and slippery  
roads..... 137

Driving on slopes and  
mountainous roads ..... 137

Driving on icy and snowy road  
..... 138

Driving in winter ..... 138

#### **Parking assist system... 138**

Introduction..... 138

Parking radar system..... 138

Reversing camera .....	141	<b>Intelligent high beam control (IHC)*</b> .....	<b>163</b>
360 panoramic view* .....	142	Switch Settings .....	163
<b>Cruise control system...</b>	<b>148</b>	Function Activated .....	163
Button description .....	148	Function triggering.....	163
Activate cruise control ....	148	Function Exit.....	163
Pause cruise control .....	149	Functional limitations .....	164
Restore cruise control.....	149	<b>Side-rear driver assistance*</b>	<b>.....164</b>
Turn off cruise control .....	149	Sensors .....	164
Speed setting.....	149	Warning light.....	165
<b>Driver assistance* .....</b>	<b>150</b>	Lane Change Assist (LCA) system .....	166
Introduction .....	150	Door Open Warning (DOW)....	.....168
<b>Forward collision assist * ....</b>	<b>.....150</b>	Rear cross traffic alarm (RCTA).....	170
Switch Settings .....	150	Rear Collision Warning (RCW) system .....	172
Forward Collision Warning (FCW).....	150		
Automatic Emergency Braking (AEB) .....	151		
Functional limitations .....	151		
<b>Lane departure assist (LDA)* .....</b>	<b>154</b>		
Switch Settings .....	154		
Function Activated .....	154		
Function triggering.....	155		
Functional limitations .....	155		
<b>Cruise assist* .....</b>	<b>157</b>		
Adaptive cruise control (ACC) .....	157		

### Starting the vehicle

#### Vehicle power-on/power-off



Carry the smart key matched with the vehicle into the vehicle.

**OFF gear:** With the vehicle in OFF gear, the Start switch indicator light is in breathing/blue status.

**ACC gear:** With the vehicle in "OFF" gear, press the Start switch without depressing the brake pedal, and the indicator light will turn breathing/blue. Switch the vehicle to "ACC" gear. At this time, the IVI system and other related functions can be used.

**ON gear:** When the vehicle in "ACC" gear, press the Start switch without depressing the brake pedal, press the Start switch once, and the indicator will turn blue. When the vehicle is switched to "ON" gear, most electrical equipment can be used. Press the Start switch again, and the vehicle will return to the "OFF" gear.

**START:** It is a gear position after the vehicle starts. When the Start switch is in the "OFF/ON/ACC" gear, press the brake pedal, make sure the gear lever is in P/ N gear, and then press the Start switch to start the vehicle directly. At this time, the Start switch indicator light is always on in

blue.

#### Start the vehicle power system

To start the vehicle, the following conditions must be satisfied:

1. The gear is in P or N.
2. Press the brake pedal until the "READY" indicator light on the instrument cluster lights up.
3. Press the Start switch, the Start switch indicator light changes from breathing/blue light to constant blue light and the vehicle starts.



#### Caution

- READY indicator lights up to indicate that the vehicle is in a drivable condition.
- If the READY indicator flashes, it indicates that the driver's door is not closed properly. Please check the door closing condition.
- The distance travelled by the vehicle is related to factors such as the remaining SOC of the power battery and the driving power of the vehicle.
- If the outside temperature is extremely low, the power battery is unavailable at this time, and you must wait until the conditions are improved before driving. In this case, the vehicle cannot be started and the READY indicator will not illuminate. If the vehicle is used in an extremely low temperature environment, please park it in an indoor environment first.
- After the READY indicator lights up, the vehicle is in a driving state. Please ensure that the vehicle is in P or N gear when not driving.



## Caution

- The discharging capacity of the power battery will be greatly limited at extremely low temperature. In order to avoid difficulty in starting the vehicle after parking, please keep the power battery high when parking the vehicle.

## Vehicle maintenance and software updates

To ensure safe operation, please press and hold the hazard warning light switch for more than 5 seconds before vehicle maintenance and inspection. The vehicle will be forced to power off, and the corresponding maintenance and inspection can be performed after entering the OFF gear. If the maintenance must be performed with the vehicle in ON gear, you can first press and hold the hazard warning light switch for more than 5 seconds to force the vehicle to power off, then depress the brake pedal before operating. However, this state will drain the 12V low-voltage battery, so do not remain in this state for too long. Press and hold the hazard warning light switch again for more than 5 seconds to exit the forced power-off mode.

## Start failure of vehicle

If the vehicle READY indicator light does not illuminate, it indicates that there may be a power failure affecting the vehicle starting or the starting conditions are not met. Please check according to the prompts on the instrument cluster:

1. When the electronic immobilizer system fails, check whether the smart key is in the car and close to the front passenger cup holder.

2. When the 12V low-voltage battery is low or the instrument cluster cannot be lit, it means that the 12V low-voltage battery may have run out of power. You can try to start the vehicle by jumping. For details, see "Jump Start" in the "Emergency self-handling" chapter.

3. When the power system fails, please contact the Forthing service station.



## Caution

If it still fails to start successfully after multiple operations, please contact the Forthing service station.

## Smart key low battery start

When the smart key battery is too low or there is no battery, you can use the mechanical key inside the smart key to open the driver's door, then put the smart key into the first cup holder of the front passenger cup holder (in the front direction of the vehicle), depress the brake pedal and press the Start switch at the same time.

## Shifting operation

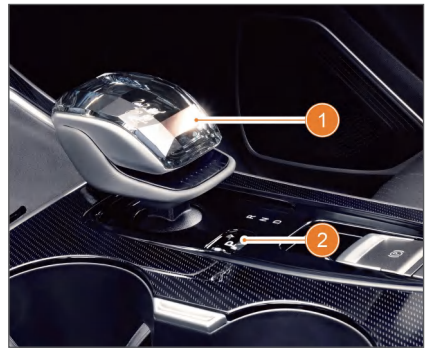

1. Shift lever      2. P gear button

## Gears introduction

### P gear (Parking Gear)

This gear is used when the vehicle is parked or placed in a state ready to drive. Press the P gear button to enter the Parking gear. Be sure to stop the vehicle completely before shifting to P gear.

### D gear (Driving gear)

Only when the vehicle is started (the READY indicator on the Instrument cluster illuminates) can the D gear be engaged. Use this gear when driving forward.

### R gear (Reverse)

Only when the vehicle is started (the READY indicator on the Instrument cluster illuminates) can the R gear be engaged. Use this gear when reversing. Be sure to stop the vehicle completely before shifting to R gear.

### N gear (Neutral Gear)

When the vehicle is in this gear, the drive motor cannot output power and will not provide auxiliary parking.

## Driving operation

### Shifting method

Before starting the vehicle, you should always step on the brake pedal; otherwise the vehicle will move if the driving gear of the shift lever has been engaged. After the vehicle is started, normal gearshift operations can be performed.

After each gear operation, the gear lever will return to the middle gear, and the gears are arranged from front to back in R-N-D order.

### Shift to P gear

Depress the brake pedal, wait for the vehicle to stop completely, press the

P gear button, and confirm that the instrument cluster displays the P gear state.

### Shift to R gear

After the vehicle is started, depress the brake pedal and push the gearshift lever forward to R gear.

### Shift to N gear

#### **P gear - N gear**

Depress the brake pedal and push the gearshift lever forward or backward to N gear.

#### **R gear - N gear**

Depress the brake pedal and push the gearshift lever backward to N gear.

#### **D gear - N gear**

Depress the brake pedal and push the gearshift lever forward to N gear.

### Shift to D gear

After the vehicle is started, depress the brake pedal and push down the gearshift lever to D gear.

### Description of gear shifting conditions

1. When the vehicle is in the ON gear, the gear can only be switched between P gear and N gear.
2. To exit the P gear, push the gearshift lever and depress the brake pedal at the same time.
3. To enter R or D gear, the READY indicator needs to be on. Press the brake pedal and operate the shift lever at the same time.
4. When the actual gear is D or R, it takes about 1 second to operate the shift lever to switch to N.

## Driving mode

The vehicle has three driving modes: Eco, Normal and Sport.

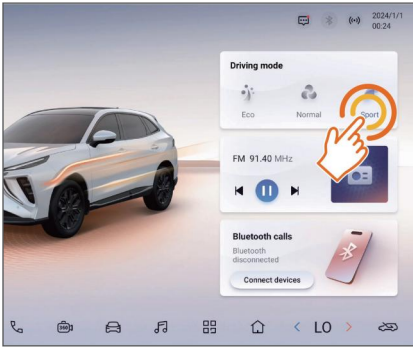

Driving mode can be entered in the following ways, and different driving modes can be selected as needed:

- Tap the [Driving mode] function card on the homepage of the multimedia display screen.
- Tap the car model on the intelligent control theme interface of the multimedia display screen to enter [Shortcut control]-[Driving mode].
- Tap [Vehicle control]-[Driving experience] in the navigation bar  at the bottom of the multimedia display screen.

In the [Driving experience] interface, you can turn on or off [Driving mode memory]. After the vehicle is powered on, it defaults to Eco mode.

### Eco mode(Eco)

In this mode, all systems of the vehicle can work under economical and energy-saving conditions. It is recommended that this mode be used first in daily use.

### Normal mode (Normal)

More attention to driving comfort, a mode that balances energy saving and performance.

## Sport mode (Sport)

In this mode, the power performance of the vehicle can be fully reflected. When using this mode, please pay attention to the road conditions and keep a safe distance from the vehicle in front.

### Caution

- When the vehicle accelerates rapidly, the driving wheels may slip, and the acceleration performance can be fully exerted only on a suitable road surface. Acceleration performance is related to weather conditions, vehicle load distribution, load conditions, road conditions, operation habits and other factors.
- The driving economy (energy consumption and driving range) is related to driving habits, road conditions, weather, load conditions, A/C, window opening, tyre pressure and other factors. In order to reduce energy consumption and extend the driving range, please gently depress the accelerator pedal to avoid rapid acceleration, and close the window when the speed is high.

## Energy recovery

The vehicle has coasting energy recovery and braking energy recovery, making your driving more economical and energy-saving.

### Coasting energy recovery

Choosing the appropriate coasting energy recovery level under different road conditions can bring you a better driving experience and longer driving range, making your car more energy-efficient and economical.

# Comfortable Driving

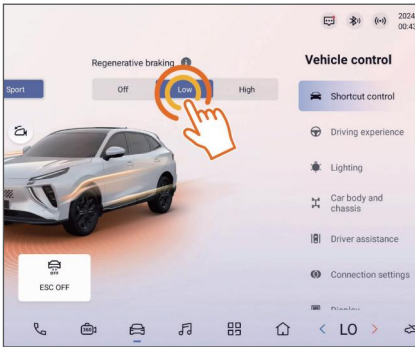

After the vehicle stops stably, tap on the vehicle model in the intelligent control theme interface of the multimedia display screen to enter [Shortcut Control] or tap [Vehicle Control]-[Driving Experience] in turn in the navigation bar  at the bottom of the multimedia display screen. Regenerative braking can be selected as [Off],[Low] or [High] according to driving habits, this option can be automatically memorized.

The coasting energy recovery is in the Off gear, and the drag feeling is weak when the vehicle coasts; in the High gear, the drag feeling is strong when the vehicle coasts.

## Braking energy recovery

When the brake pedal is depressed, the vehicle will enter the braking energy recovery mode. The braking energy recovery is generally more powerful than the coasting energy recovery, which can reduce the vehicle speed in a shorter time, obtain more energy recovery, and achieve better energy saving effect. Energy recovery may not occur under the following circumstances:

- 1.The power battery has a high power and cannot store more power.
- 2.When the vehicle speed is too low,

due to the vehicle's creeping function, after the vehicle enters D/R gear, if the accelerator pedal is not pressed and the brake pedal is released, the vehicle will travel at a lower speed without coasting energy recovery.

3.The charging capacity of the power battery is seriously limited due to extremely low ambient temperature or excessively high temperature.

4.The vehicle speed is relatively high, and the driving resistance of the vehicle is relatively large. In order to maintain good driving comfort, the coasting energy recovery is not carried out at a higher speed.

5.When the vehicle is running on muddy, icy or slippery roads, safety assistance systems (such as ABS) will be activated.

6.The vehicle has a fault that restricts driving. In case of any fault indication, please contact the Forthing Service Station.

7.When the adaptive cruise control function is activated (some models).

## Parking brake

### Electronic Parking Brake (EPB)



The EPB switch is located on the auxiliary dashboard, and the driver can

use the EPB switch to park the vehicle reliably.

## Manual activation and deactivation of EPB

**Enable:** After the vehicle comes to a standstill, pull up the EPB switch to complete manual parking, and the parking status indicator (P) will illuminate.

**Release:** Press the brake pedal, switch the gear to a non-P gear, press the EPB switch, release the parking brake, and turn off the parking status indicator (P).

## Emergency brake function

This function can only be used when the brake pedal fails or is blocked. Pull up the EPB switch continuously to realise vehicle braking with the EPB function in case of emergency. As long as the EPB switch is released, the emergency brake can be deactivated.



### Caution

When the working voltage of EPB is lower than 9V or higher than 16V, it may fail.



### Warning

The use of emergency brake function shall be avoided as far as possible. On roads with large bending, poor road conditions or slippery roads, the use of emergency brake function may lead to drifting and sideslip of the vehicle.

## AUTO HOLD



The AUTO HOLD function helps the driver to start the vehicle more comfortably on the slope section or at a traffic light intersection. This function can be turned on or off by AUTO HOLD switch. After the function is activated, the system will continue to brake when the driver releases the brake pedal at the hill start or traffic light intersection.

### Turn-on conditions of AUTO HOLD:

1. The READY indicator of the instrument cluster is not on.
2. The driver has fastened the seat belt.
3. The driver's door is closed.

### Turn on AUTO HOLD function

1. Press the AUTO HOLD switch to turn on the AUTO HOLD function, and the switch indicator will light up.
2. If the AUTO HOLD function is turned on during driving, when the driver depresses the brake pedal to stop the vehicle, the vehicle will automatically park and the AUTO HOLD indicator (A) on the instrument cluster will light up. At this time, the driver can release the brake pedal.
3. When starting the vehicle, whether on a flat road or uphill or downhill, you need to depress the accelerator pedal to

automatically release the parking brake. Otherwise, the vehicle may fail to start.

### Turn off AUTO HOLD function

1. When the AUTO HOLD function is turned on, press the AUTO HOLD switch to turn off the AUTO HOLD function, and the switch indicator will go out.

2. If the driver's door is opened, the driver's seat belt is released, or the vehicle is powered off, the AUTO HOLD will automatically exit, and electronic parking will be applied to ensure parking safety.



#### Caution

- When the electronic stability system activation indicator/MIL of the instrument cluster is on, the AUTO HOLD function will fail.
- When the working voltage of AUTO HOLD is lower than 9V or higher than 16V, the AUTO HOLD function will fail.

## Traction control system (TCS)

During the driving process of the vehicle, the slip of the wheel in its rotation direction can be reduced by properly braking the driving wheel during driving.

## Brake assist system

### Brake Assist (BA)

The driver can brake in time in most dangerous situations, but the force to depress the brake pedal is insufficient, resulting in an increase in braking distance. For vehicles with a BA system, the BA brake assist system will be activated when the brake pedal is pressed quickly while the vehicle is

driving. At this time, the BA system will generate a braking force greater than that during normal braking, so as to shorten the braking distance and ensure your safety.

### Brake priority

The brake priority system can automatically reduce the driving force of the vehicle to zero when it detects that the driver depresses the brake pedal, and then the vehicle enters the braking energy recovery state.

## Anti-lock brake system (ABS)

### Working principle

The ABS system controls the brake of the vehicle, and adjusts the braking force by detecting the speed of each wheel to prevent wheel locking and sideslip. During vehicle braking, the steering wheel can still be used to avoid collision.

### System self-inspection

The ABS has built-in self-inspection function. When the vehicle is started and running at a low speed, the system will carry out self-inspection. In case of any fault, the self-test function will turn off the ABS and illuminate the ABS fault warning light on the Instrument cluster. At this time, the brake system works normally, but the ABS does not work. If the ABS fault warning light illuminates during self-inspection or driving, please contact a Forthing service station.

### Normal operation

The ABS will start automatically when the vehicle speed reaches more than 5 km/h. When the ABS detects that one or more wheels are approaching the locked state, the actuator acts quickly to release and restore the braking force. When the

actuator is working, you may feel slight vibration of the brake pedal and hear the vibration sound from the actuator under the bonnet. This is a normal state, indicating that the ABS is working normally.



### Caution

- The ABS cannot reduce the braking distance.
- During emergency braking, the steering shall be moderate.
- The ABS system does not work when the vehicle is in P gear.

## Electronic brake distribution (EBD)

The EBD system will automatically distribute the braking force between the front and rear wheels, so that the vehicle can have good braking performance under different load conditions.

## Electronic stability control (ESC) system

The ESC system can improve the stability of driving the vehicle. When the ESC system detects that there is a deviation between the expected driving state and the actual body state, it will start to work. The ESC system will selectively apply braking force to the vehicle brakes to improve the driving stability of the vehicle.



### Caution

- If wheels, rims and brake-related components other than those recommended by Forthing are used, the ESC system may not work properly and the electronic stability system activation/MIL may illuminate.

## Enabling or disabling the ESC system

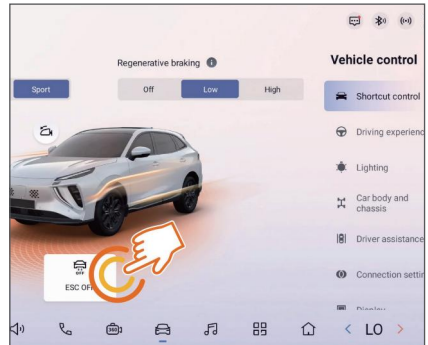

The ESC system is turned on by default. Tap the vehicle model on the intelligent control theme interface of the multimedia display screen to enter [Shortcut control] or tap [Vehicle control]-[Driving experience] in sequence in the bottom navigation bar of the multimedia display screen to turn ESC OFF on or off.

When the switch is turned on, the ESC system is turned off and the electronic stability system shutdown indicator on the instrument cluster lights up; when the vehicle speed exceeds 80 km/h, the system will automatically turn on and the electronic stability system shutdown indicator on the instrument cluster goes out.

When the switch is turned off, the ESC system will be activated and the electronic stability program OFF indicator on the instrument cluster will go out.



## Caution

- When the vehicle is in P gear, the ESC system does not work.
- Do not modify the suspension.
- The ESC system cannot replace the use of winter tyres or tyre slip prevention on snowy roads.
- Try to avoid driving on very inclined roads.
- The ESC system cannot prevent accidents caused by sudden steering at a high speed or dangerous driving techniques.
- The ESC system can help control the stability and driving force of the vehicle. Do not turn it off unless necessary.

## Suggestions for proper use of the braking system

Do not put your foot on the brake pedal when driving, which will overheat the brake, accelerate the wear of the brake disc and brake pad and increase energy consumption.

When driving down a long descent, avoid frequent braking to prevent the brakes from overheating and reducing braking performance.

Exercise caution when driving on slippery roads. Sudden braking or acceleration will cause wheel slip.

When the vehicle is washed, waded or driven in rainy days, the brake may become wet and the braking performance may be reduced. In this case, the vehicle shall be driven at a safe speed and attention shall be paid to keeping the distance between vehicles.

When coasting at a high speed, the vehicle will enter energy recovery. When

going down a long slope, the power battery may be fully charged and cannot enter energy recovery. Please keep a proper safe distance when driving the vehicle, and depress the brake pedal to control the speed if necessary.

## Hill Hold Control (HHC)

When the vehicle starts on a steep or smooth slope and the driver switches from the brake pedal to the accelerator pedal, the vehicle may slide downward, resulting in difficulty in starting. To prevent this, the HHC system will apply braking force to four wheels for a short time (about 2 seconds) to prevent the vehicle from sliding down.

The HHC system will operate automatically under the following conditions:

1. The gearshift lever is in D or R gear and the vehicle goes uphill.

2. Depress the brake pedal to bring the vehicle to a complete stop on a slope.

The HHC system will not work under the following conditions:

1. The gearshift lever is in N or P gear, or the vehicle is on a level road.

2. When the ESC OFF indicator in the instrument cluster is on.



## Warning

- Do not rely solely on the HHC system to prevent the vehicle from sliding down a ramp.
- When parking the vehicle on a steep slope, icy and muddy road, depress the brake pedal to prevent the vehicle from sliding backward.

## Hill Descent Control (HDC)

The HDC system allows the driver to smoothly pass through a steep downhill section without depressing the brake pedal.

### Enabling or disabling the HDC system



Press the HDC switch on the dashboard switch group, and the hill descent control system activation indicator on the instrument cluster will light up. When the HDC switch is pressed again or the vehicle speed exceeds 60 km/h, the hill descent control system activation indicator will go out and the HDC system will be turned off.

### Hill Descent Control system braking

When the vehicle is going downhill on a steep slope, the system will actively brake when the HDC system is turned on, so as to keep the vehicle speed within the range of 8 km/h to 35 km/h. The driver can depress the accelerator pedal or brake pedal to adjust the speed to be maintained when using the HDC function to go downhill within this speed range.

When the HDC system performs active braking, the hill descent control activation indicator on the instrument cluster flashes and the vehicle brake light illuminates.

At the same time, the ESC system of the vehicle will make a motor working sound and the brake will make a braking sound, which is normal.

### Warning

- Before using the hill descent control function, the driver needs to confirm that the system is activated.
- The HDC system controls the vehicle speed by assisting the driver to step on the brake pedal or accelerator pedal. The driver needs to pay attention to controlling the vehicle at all times to ensure driving safety.

## Brake booster

When the force applied to the brake pedal exceeds a certain level, the brake booster will be activated. At this time, even if the brake pedal is lightly pressed, it will generate a greater braking force than the vacuum booster, which is convenient for easy driving of the vehicle.

## Brake pedal feeling adjustment

The driver can adjust the brake pedal feel according to his preferences.

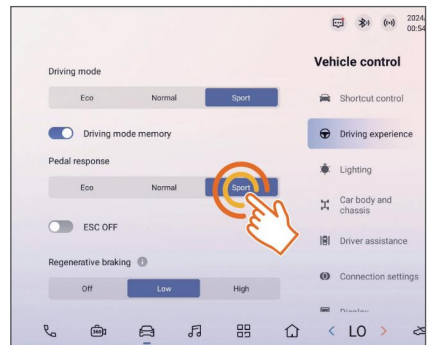

Tap  [Vehicle control]-[Driving experience] in the bottom navigation bar of the multimedia display screen in turn,

## Comfortable Driving

and select Pedal response as [Eco], [Normal] or [Sport].

After the vehicle is restarted, the brake pedal will remember the last set state.

### Comfort Stop System (CST)

In the process of braking on a flat and horizontal road, the CST system can appropriately reduce the braking pressure before the vehicle stops, so that the vehicle can be parked smoothly and the pitch jitter during parking can be reduced, thus improving the braking comfort.

#### Turn on or off the CST system

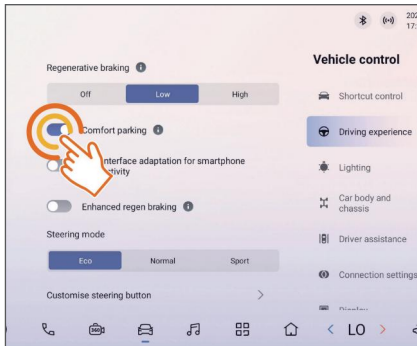

Tap  [Vehicle control]-[Driving experience] in the bottom navigation bar of the multimedia display screen to turn on or off [Comfort parking].

After the vehicle is powered on again, the CST system will memorize the last setting state.

#### Brake-by-wire system

The brake-by-wire system can detect the driver's braking intention and provide braking pressure.



#### Caution

Failure conditions of CST function:

- The vehicle is in P or R gear.
- CST system is shut down.



#### Caution

- On bumpy, potholed or sloped roads.
- The brake pedal is depressed too lightly or the braking force is excessive.
- The steering wheel angle or lateral acceleration is too high.
- The brake disc temperature is too high.
- Emergency conditions such as ABS, EBD and BA occur during braking.
- The brake pedal is not stable or the driver's braking intention is not gentle.
- Brake-by-wire system fault.
- The brake-by-wire system will generate noise under the following conditions:

● After the vehicle is started, a short "tick-tack" sound will be produced. This is the self-inspection sound of the brake-by-wire system and it is normal.

● When the vehicle accelerates to about 15 km/h, it will also produce a short "buzz" sound, which is the sound of ABS self-inspection and is a normal phenomenon.

The brake-by-wire system may produce sounds during normal operation, primarily in the following situations:

1. Operating noise of the motor, solenoid valve and pump in the brake-by-wire system.
2. Sound caused by rebound of brake pedal.
3. After the vehicle is started, the brake-by-wire system will conduct self-inspection. During self-inspection, it is normal to hear a "tick-tack" sound when depressing the brake pedal.

## Electric Power Steering (EPS)

The electric power steering system can provide power during driving, so that the driver can turn the steering wheel easily.

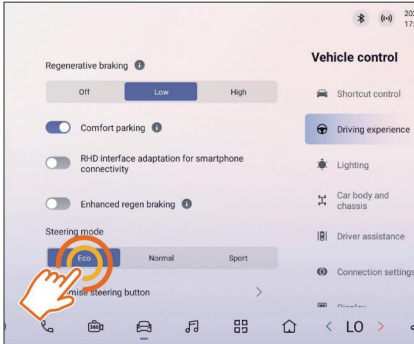

Tap [Vehicle control]-[Driving experience] in turn in the bottom navigation bar of the multimedia display screen to select the steering mode as [Eco], [Normal] or [Sport].

**Eco:** The power steering is increased and the steering is easier.

**Normal:** Moderate power steering, suitable for general driving habits. This item is the default state.

**Sport:** The power steering is reduced and the steering feels stable.



### Caution

- Please select the steering mode when the vehicle is stationary and no steering operation is performed.
- When turning the steering wheel quickly, you may hear the working sound of the power steering motor, which is a normal state and not a fault.



### Caution

- During parking or driving at a very low speed, if the steering wheel is repeatedly and continuously turned or turned to the end for a long time, the electric power steering system will be overheated, and the power of the steering motor will decrease or even fail to provide power temporarily. In order to avoid this situation, don't do similar operations.

## Suggestions for driving

### Safety Driving Notice

In case of a serious traffic accident or severe front, side and rear collisions, immediately press the hazard warning light switch for more than 5 seconds to turn off the power supply of the vehicle. All personnel in the vehicle get off and contact the Forthing Service Station.

Avoid driving the vehicle through road sections with pits, many big stones, potholes and excessively high buffer zones as far as possible, and avoid wading to prevent the battery pack from being soaked in water. If an abnormality occurs, first ensure the safety of personnel, press and hold the hazard warning light switch for more than 5 seconds to turn off the power supply of the whole vehicle, and contact the Forthing service station.

### Driving at night

Driving at night is more dangerous than driving at daytime, mainly because of poor night vision and fatigue of drivers. Please pay attention to the following matters when driving at night:

## Comfortable Driving

1. Driving under the influence is strictly prohibited.
2. Adjust the position of the interior rearview mirror to reduce glare.
3. Keep a greater distance from the front vehicle.
4. Drive carefully and watch out for animals.
5. Drive at a low speed.
6. Pay attention to the dazzling light of the meeting lights. Slow down to avoid looking directly at the headlights of the oncoming vehicle.
7. Do not drive tiredly. If you are sleepy, park the vehicle at a safe place on the roadside in time for rest.
8. Keep all glasses clean and tidy, avoid dazzling lights and obstructing sight.

### Driving Through Water

In order to avoid damaging the vehicle when driving through water, pay attention to the following matters:

1. Determine the water depth before driving through water. The maximum water level can only reach 1/4 of the height of the wheel.
2. Drive at a maximum speed of 10 km/h. If the vehicle speed is too high, waves may be formed in front of the vehicle, causing water to enter the components of the vehicle, resulting in vehicle damage.
3. Under no circumstances should the vehicle be parked, reversed or powered off in water.



#### Caution

- The braking effect may be affected and the braking distance may be prolonged when the vehicle passes through waterlogged or muddy roads, which may cause accidents!



#### Caution

- Avoid rapid acceleration or emergency braking immediately after driving through water.
- When driving through water, some parts of the vehicle, such as drive motor, chassis or electrical system, may be damaged.
- After driving through water, when traffic conditions permit, the brake must be cleaned and dried as soon as possible through intermittent braking. Do not affect other traffic participants to avoid traffic accidents.
- The waves caused by the opposite vehicle may exceed the allowable water height of this vehicle.
- There may be ponding, mud pits or stones hidden in the water, which will make it more difficult for or hinder wading.
- Avoid driving on a road with more water accumulation as far as possible. After driving on a road with more water accumulation, it is recommended to drive the vehicle to a Forthing service station for a comprehensive inspection to eliminate hidden dangers and ensure driving safety.

### Long-distance driving

Before long-distance driving, please make sure that relevant preparations are made and try to have a good rest.

Please check the following components of the vehicle before traveling:

1. Check whether the washer fluid reservoir is full and whether the inner and outer sides of all windows are cleaned.
2. Check whether the fluid reaches the

specified level.

3. Check whether all lights work normally.
4. Check whether the light surface is clean.
5. Check whether the tyre tread pattern is suitable for long-distance driving and whether all tyres have been inflated to the recommended air pressure value.

### Driving on rainy and slippery roads



Please pay attention to the following items when driving in rainy days:

1. Heavy rain will make the sight worse and increase the braking distance. Please slow down.
2. The wiper should be checked frequently. If there are stripes or missing areas on the windscreen, please replace the wiper blade in time.
3. If the tyres of the vehicle are in poor condition, braking on a slippery road may cause the vehicle to slip or even cause an accident. Therefore, please ensure that the tyres of the vehicle are in good condition.
4. Turn on the vehicle headlight and hazard warning light.
5. Please be sure to slow down when passing through waterlogged roads.
6. If the brake is wet, please gently

depress the brake pedal during driving until the brake returns to normal.

7. During driving, do not turn sharply or depress the brake pedal suddenly to avoid accidents.
8. After driving through water, slowly depress the brake pedal to dry the brake when driving at a low speed.

### Driving on slopes and mountainous roads



When driving on slopes and mountainous roads:

1. Please keep the vehicle in good condition.
2. Pay special attention when climbing over the top of the slope, because there may be obstacles in your lane.
3. Special warning signs may be seen on mountain roads, so please pay attention to these signals and take appropriate measures when driving.

## Comfortable Driving

### Driving on icy and snowy road



1. When driving in snow, use snow tyres as much as possible. Please select snow tyres of the same size and model as those originally assembled.
2. When driving in snow, high speed, rapid acceleration, emergency braking and small angle turning are very dangerous and should be avoided as much as possible.
3. When driving on ice, emergency braking will cause the vehicle to drift. Please keep a safe distance.

### Driving in winter



Harsh driving environment in winter will increase vehicle wear or cause vehicle failure. The probability of failure can be reduced by referring to the following recommendations:

1. Check the coolant specification to confirm that the freezing point is suitable for the expected temperature in winter. If the requirements are not met, replace the coolant that meets the requirements.
2. Check the wiper to ensure that the wiper blade can wipe freely.
3. Carry appropriate emergency equipment according to weather changes.

## Parking assist system

### Introduction

The parking assist system can assist the driver to observe and perceive the surrounding environment during low-speed driving or parking, and provide the driver with visual and audible prompts or warnings when there are obstacles hindering driving or parking.

The main functions of the parking assist system include:

1. Parking radar system.
2. Reversing image.
3. 360° panoramic view\*.

### Parking radar system

The parking radar system can detect obstacles around the vehicle when the vehicle is running at a low speed and give a warning when the vehicle is approaching obstacles to assist the driver in ensuring reversing safety.

According to different configurations, the parking assist system radar sensors are divided into two categories:

#### Type I

Four radar sensors in the rear.

#### Type II

Four radar sensors in front and four in rear.

When the parking radar system is turned on, the system will automatically detect whether the function is normal. If the system is normal, it will beep 1 time for 0.5 seconds. If the system beeps 1 time for 3 seconds, it indicates that there is a fault in the system. Please contact Forthing Service Station.

## Front radar\*

The front radar can be turned on or off in the following ways:

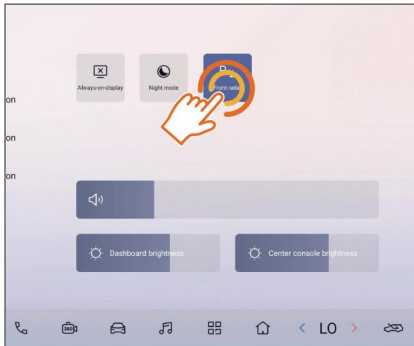

Method 1: Tap [Front radar] in the drop-down shortcut menu of the multimedia display screen.

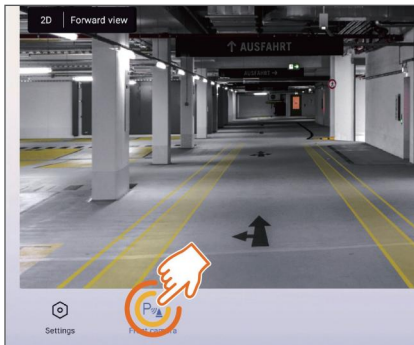

Method 2: Tap [Front camera] on the 360° panoramic view interface.

## On

When the vehicle is powered on, the front radar system is in the state set after the vehicle power was turned off last time.

The front radar can be turned on when the following operations are met at the same time:

1. The Start switch is in the ON position.
2. Turn on the front radar switch.
3. The gearshift lever is not in P gear.
4. The EPB switch is released.
5. The speed is not greater than 15 km/h after starting or the vehicle decelerates from a higher speed to 10 km/h during driving.

## Close

The front radar system can be turned off by the following operations:

- The Start switch is not in the ON position.
- Press the P gear button.
- Pull up EPB switch.
- The vehicle speed exceeds 15 km/h.
- Turn off the front radar soft switch.

## Turning on/off method of reversing radar

With the vehicle powered up, when the shift lever is shifted to R gear, the reversing radar will be turned on automatically; after the gearshift lever is disengaged from R gear, the system will be turned off automatically.

## Detection range

The detection range of the parking assist system radar sensor is shown in the table below:

Sensor position	Maximum detection distance (cm)
Both front sides *	70
Front middle *	120
Both rear sides	70
Rear middle	150

# Comfortable Driving

## Warning mode

When an obstacle is detected within the detection range of parking radar, an alarm will be displayed on the multimedia display screen and an audible alarm will be given. The closer the vehicle is to an obstacle, the quicker the alarm sound will be. When the vehicle is about to collide with an obstacle, the alarm will sound for a long time. At this moment, do not continue driving to avoid collision.



As the distance from the obstacle changes, color distinction and alarm are performed on the reversing image or 360 panoramic view interface.

## Fault display

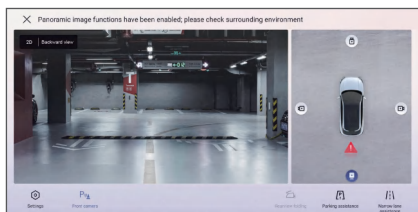

When a warning sign is displayed at the position of the radar sensor, it indicates that the radar sensor fails. When one or more radar sensors in the front of the vehicle fail, the remaining sensors in the front will not work; when one or more radar sensors in the rear of the vehicle fail, the remaining sensors in the rear will not work. In case of the above situation, please contact Forthing Service Station in time.

## Conditions in which the system may not work

Due to the characteristics, position, angle, size, material or complex background of objects, the system may not work or give false alarms. The following conditions may cause failure to detect or poor detection:

- Wire mesh, steel ropes and other objects.
- Driving in grass or on rough roads.
- Cotton or acoustic material.
- Foreign object is attached to the sensor surface.
- Ultrasonic noise, metal sound and high-pressure gas emission sound at the same frequency.
- The non-standard wireless communication devices installed in the vehicle may also affect the function of this system during use.



## Warning

- The parking assist system is only used as an auxiliary warning for obstacles in front of and behind the vehicle during parking and reversing, and cannot replace the driver's observation of the surrounding environment. The driver needs to monitor the environment in real time during the whole driving process, and Dongfeng Forthing is not responsible for accidents caused by the driver's negligence.
- As the parking assist system has blind spots, please do not use it as the only basis for reversing safety. The driver is responsible for driving safety.

## Reversing camera



The reversing camera collects images through the camera installed at the rear of the vehicle, which is convenient for the driver to check obstacles behind in time when reversing.

### Function on/off

When the Start switch is in the ON gear and the shift lever is pushed to the R gear, the reversing image will automatically turn on. After exiting the R gear, the system will automatically turn off.

### Reversing auxiliary line



#### 1. Auxiliary line

The width of the vehicle is indicated by two thin lines (width of the exterior rearview mirror + 7 cm), and the distance from the vehicle to the object is indicated

by segmented scale lines. The scale line is divided into two sections of 0.3~1 meter and 1~1.5 meters.

#### 2. Tyre track surface

It indicates the driving route of wheels.

#### 3. Reference line

It indicates the position about 0.3 m behind the vehicle.

The reversing auxiliary lines can assist you in judging the reversing trajectory; they will only activate after the steering wheel has been turned to a certain angle.



### Caution

- The auxiliary line is only for reference and cannot be used as the basis for judging the actual distance and driving track of the vehicle. Please pay attention to the surrounding environment of the vehicle and drive safely when parking the vehicle.

- The camera is similar to the human eye and has a limited ability to see objects in environments such as dusk, night, dawn, snow, rain and fog. The reversing image is mainly used for driving assistance, and the driver always has the responsibility to keep a distance from any obstacle.

- There is a certain error between the reversing auxiliary line and the actual distance. Please pay attention to the safety around the vehicle when parking the vehicle.

- A dirty camera will affect the use of the system. Please clean it up in time.

- When the weather is harsh and the light is insufficient, the system cannot be used normally.

## Comfortable Driving

### 360 panoramic view\*

The 360 panoramic view can be spliced with images from four cameras at the front, rear, left and right of the vehicle to form an aerial view on the multimedia display screen. It is used together with the reversing radar to make it safer and more convenient to park the vehicle.



#### Prerequisites for entering 360° panoramic view

1. The Start switch is in the ON position.
2. Vehicle speed is less than or equal to 30 km/h.

#### Enter 360° panoramic view

After the above prerequisites are met, any of the following methods can be used to enter the 360° panoramic view:



1. Press the 360° panoramic view button on the steering wheel.
2. Tap  in the bottom navigation bar of the multimedia display screen.
3. Tap  [System Apps]-[Panoramic images] in the bottom navigation bar of the multimedia display screen.

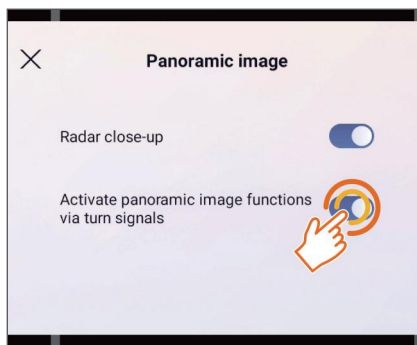

4. In the 360 panoramic view setting interface, turn on [Activate panoramic image functions via turn signals] and turn on the left and right direction indicators to enter directly.
5. When shifting to R gear, it will enter directly.

#### Exit 360° panoramic view

You can exit the 360° panoramic view in any of the following ways:

1. Press the 360° panoramic view button on the steering wheel.
2. In the 360° panoramic view interface, press the button in the upper left corner  of the interface.
3. Switch from R gear to P gear, delay 5 seconds.
4. Shift from R gear to D gear and the vehicle speed is greater than 30 km/h.
5. The turn signal returns to the centre.
6. The vehicle speed is greater than 30 km/h.



#### Caution

When the vehicle starts to decelerate from a high speed, the speed needs to be reduced to 25 km/h before it can be turned on again.

## Panoramic image functional description

The following interfaces are schematic diagrams, please refer to the actual vehicle.

### 2D view

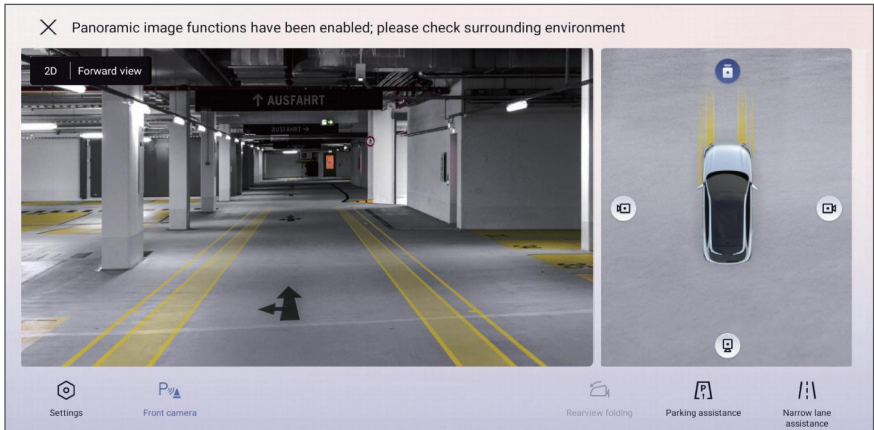

Tap the car model on the view or any position around it to display the front, rear, left and right icons. Then tap the icon at the corresponding angle to switch to the corresponding perspective (the icon will automatically fold if there is no operation for 5 seconds).

### Settings

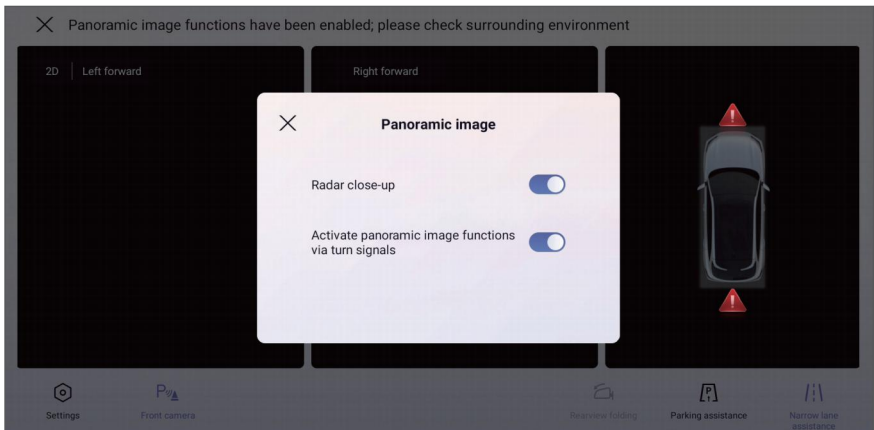

Tap [Settings] at the bottom of the 360° panoramic view interface to enable or disable [Radar close-up] and [Activate panoramic image functions via turn signals]. Radar close-up and Activate panoramic image functions via turn signals are turned on by default, both with memory function.

# Comfortable Driving

## Dynamic auxiliary line

There are auxiliary lines in the 2D front and rear single view (left) and splicing view (right). The auxiliary lines switch between the front and rear directions with the switching between D gear and R gear. The actual length indicated by the auxiliary lines is 5m.

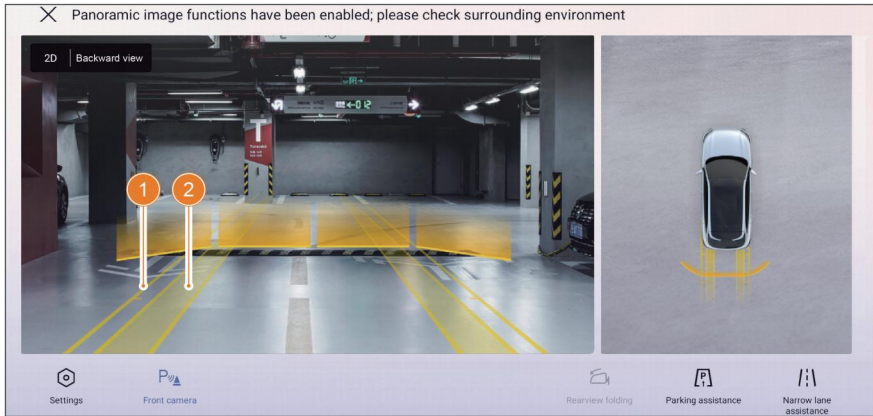

### 1. Auxiliary line

The width of the vehicle is indicated by two thin lines (width of the exterior rearview mirror + 7 cm), and the distance from the vehicle to the object is indicated by segmented scale lines. The scale line is divided into three sections: 0~0.3 meters, 0.3~1 meter, and 1~1.5 meters.

### 2. Tyre track line

It indicates the driving route of wheels.



### Warning

The auxiliary line is only for reference and cannot be used as the basis for judging the actual distance and driving track of the vehicle. Please pay attention to the surrounding environment of the vehicle and drive safely when parking the vehicle.

## Radar obstacle board display

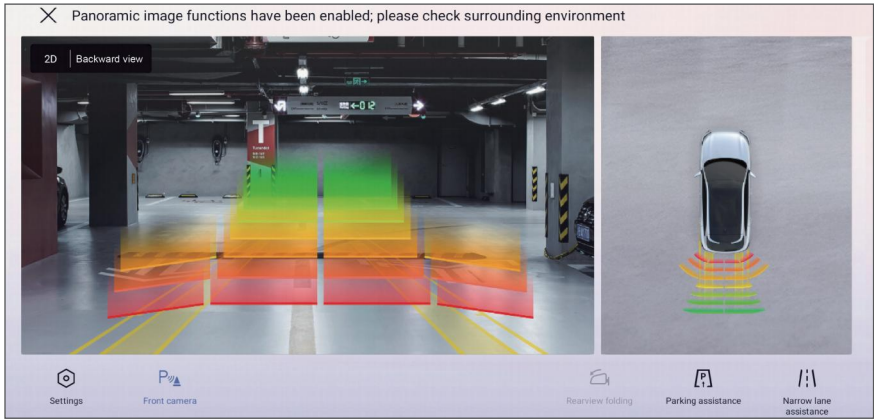

In the 360 panoramic view interface, when the working conditions of the radar system are met, the obstacle board will be displayed and an alarm sound will be given.

## Steering view

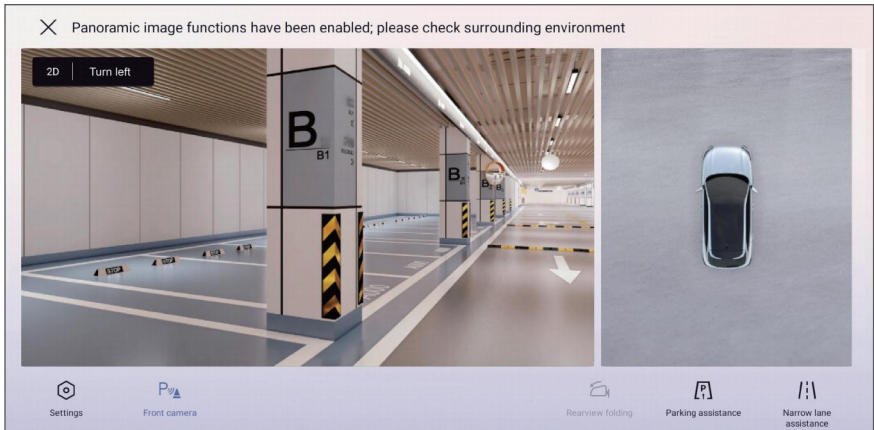

After turning on the [Activate panoramic image functions via turn signals] function (the gear is not in R gear), turn on the left/right turn signal to enter the corresponding left/right steering angle. After the light control handle is straightened, it will exit the 360° panoramic view interface after a delay of 1 second.

# Comfortable Driving

## Narrow road assist

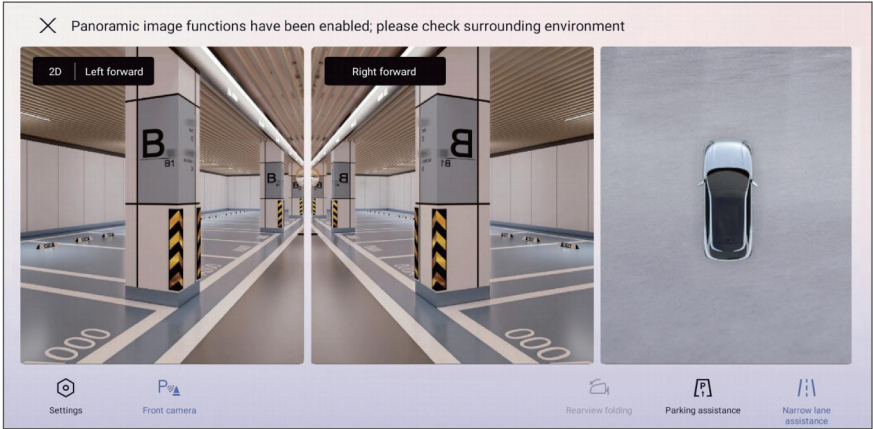

Tap  [Narrow lane assistance] at the bottom of the 360 panoramic view interface to enter the narrow lane assistance view, which displays the actual front left and front right images of the vehicle.

## Parking assistance

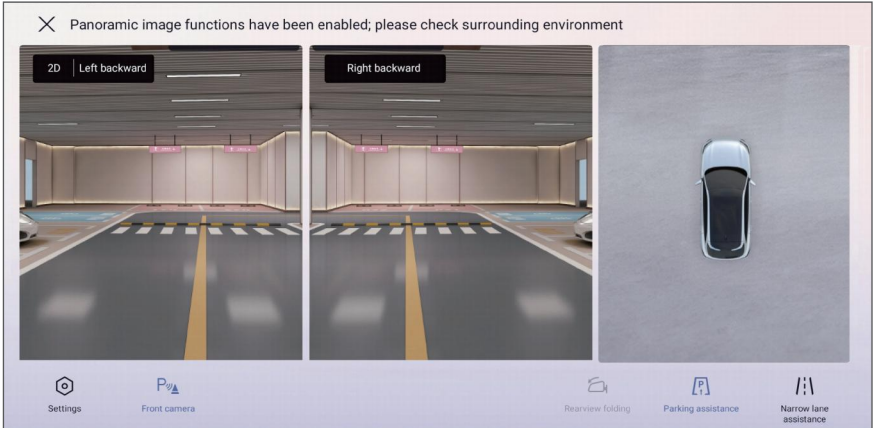

Tap  [Parking assistance] at the bottom of the 360 panoramic view interface to enter the parking assistance view, which displays the actual pictures of the left and right wheels of the vehicle.

## Fault prompt

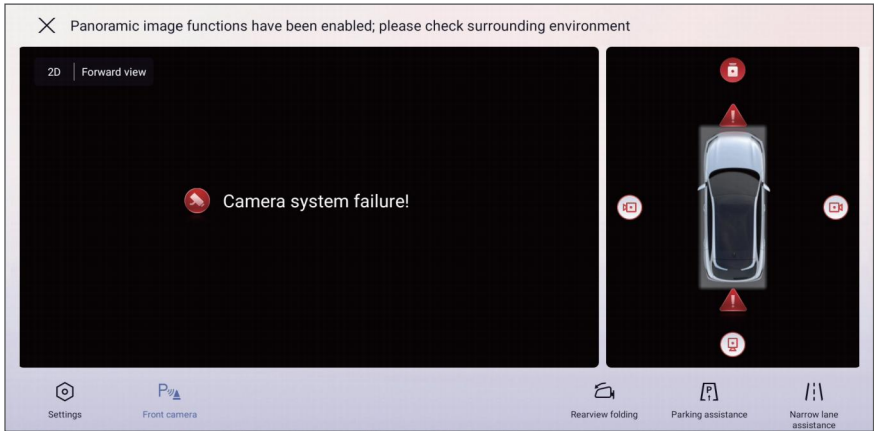

When the vehicle radar, camera or panoramic view system fails, please go to a Forthing service station for repair in time.

### Warning

360 panoramic view is only a driver assistance function and cannot cope with all traffic, weather and road conditions. As the driver of the vehicle, you are responsible for driving safety. Do not rely on this function to control the vehicle; otherwise, injury or even death may be caused.

### Caution

- The 360 panoramic view camera will magnify and distort the image with a slight delay, so the 360° panoramic view cannot replace the driver's operation and judgment. Please always pay attention to the safety around the vehicle during use.
- The camera is similar to the human eye and has a limited ability to see objects in environments such as dusk, night, dawn, snow, rain and fog. The 360 panoramic view is mainly used for driving assistance, and the driver always has the responsibility to keep a distance from any obstacle.
- The 360 panoramic view is only used to splice the ground images. For objects with a certain height, there will be blind spots in the air. When parking the vehicle, be sure to pay attention to young children, concrete columns and other objects around the vehicle.
- There will be a certain error between the auxiliary line and the radar wave distance and the actual distance. Please pay attention to the safety around the vehicle when parking the vehicle.
- A dirty camera will affect the use of the system. Please clean it up in time.



## Caution

- When the weather is harsh and the light is insufficient, the system cannot operate normally.
- Due to various factors such as ground flatness, vehicle load, tyre pressure, etc., the lane lines and curbs presented by the 360 panoramic view may be misaligned or doubled, and objects at the joints may not be fully displayed.

## Cruise control system

The cruise control system allows the driver to keep the vehicle running at a preset speed higher than 40 km/h without depressing the accelerator pedal. This function can be enabled when driving on an expressway. It is not recommended to start this function in urban areas, winding roads, slippery roads, heavy rain or other severe weather conditions.

### Button description

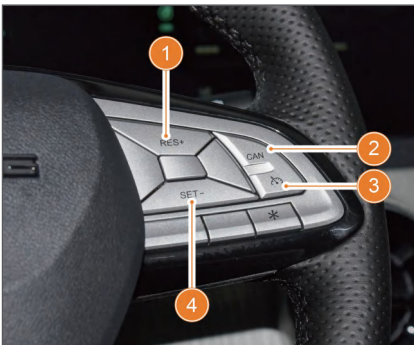

1. Cruise control recovery/acceleration button

Restore the set cruise speed and drive at the set speed.

If the cruise control function is turned on:

Short press this button: Increase the set

cruise speed by 1 km/h.

Long press this button: The cruise set speed continues to increase at 5 km/h until the button is released.

2. Cruise control pause button

Press this button to pause the cruise function.

3. Cruise control button

Press the button to turn on or off cruise control.

4. Vehicle speed settings/deceleration button

Set the current speed to the cruise speed and control the vehicle at this speed.

If the cruise control function is activated:

Short press this button: Decrease the set cruise speed by 1 km/h.

Long press this button: The cruise set speed continues to decrease at 5 km/h until the button is released.



## Caution

When the vehicle moves up or down a slope, the cruise control cannot maintain the pre-set speed. When the downhill speed increases, the brake pedal can be used to decelerate, which will pause the cruise control function. If you want to restore the original set speed, press the cruise control resume/acceleration button.

### Activate cruise control

Press the cruise control button, the system enters standby mode. The cruise control ON (not activated) indicator on the instrument cluster lights up.

If the following conditions are met, cruise control can be activated and the cruise control activation indicator on the instrument cluster will light up:

1. Press the cruise control button.
2. The vehicle speed is within the range of 40 ~ 185 km/h.
3. Press the vehicle speed settings/ deceleration button.
4. Brake pedal is not depressed.
5. The vehicle is in D gear.
6. The system has no faults.

## Pause cruise control

Any of the following methods will suspend cruise control:

- Slightly depress the brake pedal.
- Shift to a gear other than D.
- Press the cruise pause button.

## Restore cruise control

When the cruise control function is suspended, if it needs to be restored, you can first accelerate to more than 40 km/h. After meeting the cruise control activation conditions, press the cruise control resume/acceleration button to re-enter the cruise control state, and the vehicle will return to the originally set cruise speed.

## Turn off cruise control

Any of the following methods will turn off cruise control:

- Press the cruise control button.
- The cruise control system fails.
- Switch the transmission gear to the N gear.

## Speed setting

The cruise speed can be changed by any of the following methods:

- Short press the cruise control recovery/acceleration button or the vehicle speed setting/deceleration button to gradually increase or decrease the vehicle speed by 1 km/h, and long press

the corresponding button to continuously increase or decrease it by 5km/h.

- Depress the accelerator pedal, release it when the required speed is reached, and press the Speed Setting/ Deceleration button.
- Gently step on the brake pedal, release the brake pedal when the required speed is reduced, and press the speed setting/deceleration button.



### Caution

- When the vehicle speed is lower than 40 km/h, cruise control will not be enabled.
- When the system fails, cruise control will not be enabled.
- It is not recommended to enable this function in urban areas, winding roads, slippery roads, heavy rain or other severe weather conditions.
- When the vehicle is driving in cruising state, you can still accelerate and overtake by stepping on the accelerator pedal. After overtaking, remove your foot from the accelerator pedal. If the cruise conditions are still met, the vehicle will return to the preset cruise speed.



### Warning

It is strictly prohibited to use the cruise control system on icy and snowy roads.

## Driver assistance\*

### Introduction

The driver assistance system can assist the driver in observing and perceiving the surrounding environment during driving, and provide collision warning, active safety, and cruise assistance for the driver.

The main functions of the driver assistance system include:

1. Forward collision assist.
2. Lane departure assist (LDA).
3. Cruise assist.
4. Intelligent high beam control.
5. Side-rear driver assistance.



### Caution

The following situations may cause ADAS camera recognition obstacles, making the assisted driving unable to operate as expected. Please clean the windscreen with a wiper in time or contact the Forthing service station to ensure the camera's field of view. This includes, but is not limited to:

- The detection part of the ADAS camera is blocked by foreign objects (such as labels and additional parts), which affects the performance of the camera.
- The front windscreen ADAS camera sensor area may be blocked by snow, ice, dust or mud.
- When the ADAS camera needs to be cleaned, the instrument cluster prompts that the camera needs to be cleaned.

### Forward collision assist \*

Forward collision assist includes forward collision warning (FCW) and automatic

emergency braking (AEB). During driving, it provides alarm prompts and auxiliary braking for the driver when there is a risk of collision in front of the vehicle.

### Switch Settings

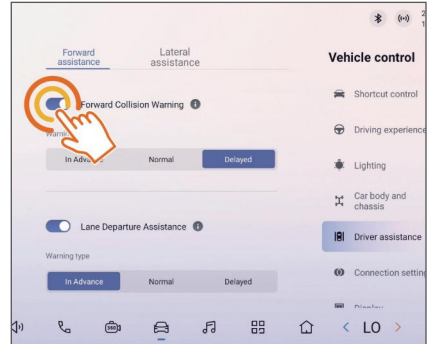

Tap [Vehicle control]-[Driver assistance]-[Forward assistance] in turn in the bottom navigation bar of the multimedia display screen to enable or disable [Forward Collision Warning]. It is enabled by default.

After the switch is turned on, you can choose warning type as [In Advance], [Normal] or [Delayed]. The default is [Normal].

When this function fails or is turned off, the forward collision assist indicator of the instrument cluster will stay on.



### Caution

When the Forward Collision Warning switch is turned on, it does not mean that the function is activated. The function will only be activated when the working conditions are met.

### Forward Collision Warning (FCW)

When the vehicle is running, if it is detected that the front vehicle, cyclist or pedestrian is too close to this vehicle,

the FCW system will remind the driver to pay attention through visual and auditory means.

### Function Activated

After the Forward Collision Warning switch is turned on, the function will be activated when the vehicle speed is greater than or equal to 8 km/h to monitor the conditions in front of the vehicle in real time.

### Function triggering

Level 1 alarm: It is triggered when the vehicle may be in danger of collision. The forward collision assist indicator of the instrument cluster flashes. The front of the driving interface turns red, and the text prompts the danger ahead with a medium-frequency alarm sound.

Level 2 alarm: It is triggered when the vehicle is about to collide. The forward collision assist indicator of the instrument cluster flashes. The front of the driving interface turns red, and the text prompts the danger ahead with a high-frequency alarm sound.



### Warning

The following operations may cause the FCW not to issue an alarm, including but not limited to:

- When the driver is already braking.
- The driver depresses the accelerator pedal deeply or sharply.
- The driver turns the steering wheel suddenly.

## Automatic Emergency Braking (AEB)

When the vehicle is running, if it is detected that the front vehicle, cyclist or pedestrian is about to collide with this

vehicle, AEB system will automatically perform emergency braking to avoid collision or reduce injuries caused by collision.

### Function Activated

After the Forward Collision Warning switch is turned on, the function will be activated when the vehicle speed is within 8 ~ 85 km/h. It monitors the conditions in front of the vehicle in real time and triggers automatic emergency braking when a collision is about to occur.

### Function triggering

When automatic emergency braking is triggered, the forward collision assist indicator on the instrument cluster flashes, the front of the driving interface turns red, and text prompts the danger ahead with a high-frequency alarm sound. The maximum speed reduction range is 60 km/h. For example: AEB is triggered when the vehicle speed is 80 km/h, and braking ends after the vehicle speed drops to 20 km/h.

### Functional limitations

The following situations may cause camera recognition obstacles, making forward collision assist unable to work as expected. This includes, but is not limited to:

- The installation position of the ADAS camera is changed.
- ADAS camera is blocked or dirty.
- Reduced identification ability at night.
- Dim surrounding environments, such as at dawn, dusk, at night, in tunnels.
- Sudden changes in the brightness of the surrounding environments, such as tunnel entrances or exits.
- Large shadows cast by buildings,

## Comfortable Driving

landscapes, or large vehicles.

- The ADAS camera is exposed to oblique sunlight or direct light.
- Severe weather like rain, snow, fog, and haze.
- Exhaust, water spray, snow or dust raised by the vehicle ahead.
- Water, dust, slight scratches, grease, dirt, wipers, freezing, snowfall, etc. on the windscreen in front of the ADAS camera.
- Wet road surface.
- ADAS camera out of focus or fault

Only qualified vehicles, cyclists and pedestrians in the same direction will be responded to by forward collision assist. The following targets will not be responded to, including but not limited to:

- Oncoming traffic.
- Side-crossing vehicle.
- Animals.
- Traffic lights.
- Wall.
- Barricades (cones, etc.).
- Other non-vehicle objects.

The following situations may cause the automatic emergency braking to not brake or stop braking, including but not limited to:

- The driver depresses the accelerator pedal deeply or sharply.
- The driver turns the steering wheel violently.
- The driver does not fasten the seat belt.
- Any door is not closed.
- Automatic emergency braking cannot be triggered again immediately after being triggered.

- No vehicle, cyclist or pedestrian is detected ahead.



### Caution

- In complex traffic situations, the forward collision assist may not identify the vehicle in time, resulting in lagging alarm prompts.
- The braking distance will be longer on a wet and slippery road. If the anti-lock brake system, traction control system and electronic stability control system are triggered, the ability of automatic emergency braking to mitigate collision may be reduced or even it may not be triggered.
- Forward collision assist can only identify licensed and legal vehicles driving on the road, and cannot detect vehicles in all cases. For example, the rear of the vehicle is seriously blocked, the shape of the vehicle is strange (such as an overloaded vehicle transporting trees), and the rear of the vehicle is seriously damaged.
- Forward collision assist can identify unobstructed adults of normal height, but cannot detect pedestrians in all cases. For example, pedestrians who are partially blocked, whose body shape cannot be recognised by their clothes, who are too short or too high, carry large objects, or have poor contrast.



### Caution

- FCA can identify cyclists with clear and complete body contours, main features and bicycle contours, but it cannot detect them in all cases, such as when the bicycle is travelling fast, or when the characteristics of cyclists or bicycles are covered by clothes or other items, resulting in unclear contours.
- The response capability of forward collision assist is limited, and the alarm prompt and automatic braking may not be triggered in time. For example, when a vehicle ahead forcibly enters the driving lane under extreme conditions or a pedestrian suddenly enters the driving lane, it may not be able to give an alarm in time.
- The recognition function of the FCA requires sufficient contrast between pedestrians and the environmental background, and too bright or too dark light has a negative impact on the system. If the pedestrian is detected or cannot be detected at all due to pedestrian posture or environmental impact, the alarm prompt will also be delayed or cannot be activated.
- Under special or complex road conditions such as winding, sharp turns, muddy and congested roads, forward collision assist may not work as expected. When the sensor is blocked by ice, snow or dust, the system may not be able to detect the vehicle ahead. Please clean the front windscreen in time.



### Caution

- Targets in the blind spot of sensors, vehicles in adjacent lanes with only part of their body cutting into the front of the vehicle, on slopes or turning through roads, etc., may cause forward collision assist to fail to operate as expected because the target is not directly ahead.



### Warning

- During automatic emergency braking, the brake pedal will automatically move downward quickly. Therefore, objects cannot be placed under the pedal to affect its free movement.
- Automatic emergency braking cannot be used to maintain a safe driving distance from vehicles, cyclists and pedestrians ahead. Please avoid being too close to the front vehicle, cyclists or pedestrians or driving aggressively.
- Automatic emergency braking is only used to mitigate the impact of a frontal collision. When the vehicle is in the reverse gear, AEB does not work.
- Forward collision assist is for reference only and cannot replace your attention and judgment. Forward collision assist is only a driving assistance function, which cannot cope with all traffic, weather and road conditions, nor can it detect vehicles, cyclists or pedestrians in all cases. It may fail, be ineffective or delayed due to several factors.



## Warning

- After the Forward Collision Warning switch is turned off, the vehicle will not warn of possible collision risks. It is strongly recommended that you do not turn off this function. To ensure your driving safety, this function will be activated every time the vehicle is restarted.
- After turning off the ESC system, the forward collision assist function will be automatically turned off. Please pay attention when using the car.
- You must always pay attention to the traffic conditions and road environment. Do not rely on the judgment of forward collision assist. Otherwise, personal injury or vehicle damage may be caused. For safety reasons, do not deliberately drive towards vehicles, cyclists or pedestrians to test the forward collision assist function. If you find danger, do not wait for the forward collision warning to be triggered before taking action. You always bear the ultimate responsibility for safe driving and must comply with current traffic laws and regulations.

## Lane departure assist (LDA)\*

Lane departure assist (LDA) includes lane departure correction and lane departure warning. When the vehicle unconsciously deviates from the lane during driving, it provides steering correction and alarm prompt for the driver.

## Switch Settings

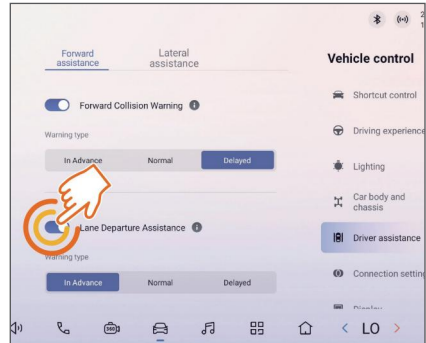

Tap [Vehicle control]-[Driver assistance]-[Forward assistance] in turn in the bottom navigation bar of the multimedia display screen to enable or disable [Lane Departure Assistance]. It is enabled by default.

After the switch is turned on, you can choose Way of assistance as [Warning] or [Warning & correction]. The default is [Warning].

You can choose the warning type as [In Advance], [Normal] or [Delayed]. The default is [Normal].



## Caution

When the Lane Departure Assistance switch is turned on, it does not mean that the function is enabled. The function will only be activated when the working conditions are met.

## Function Activated

After the Lane Departure Assistance switch is turned on, when the lane lines are clear and the vehicle speed reaches more than 65 km/h, the function will be activated. When the driver unconsciously deviates from the current lane, it provides steering warning or controls the steering wheel to correct the vehicle's deviation.

## Function triggering

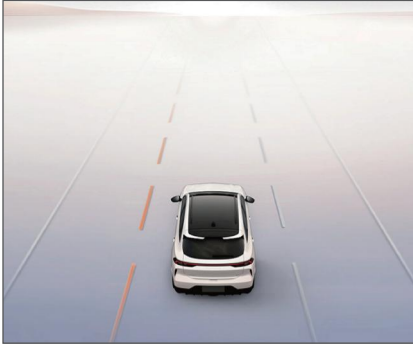

When the vehicle speed is within the range of 65 to 140 km/h, the vehicle will automatically correct back to its original lane when it may deviate from the lane. During the correction, the driving interface of the instrument cluster deviates from the lane line and turns yellow.

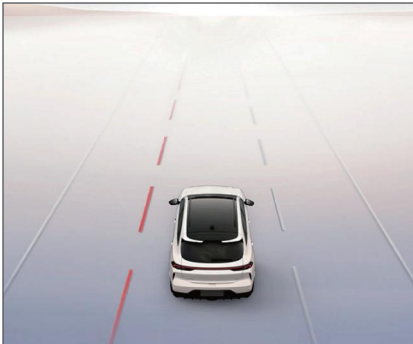

When the vehicle speed is within the range of 65 to 180 km/h, the driver will be reminded when the vehicle may deviate from the lane. During the warning, the lane line on the departure side of the Instrument cluster driving interface turns red, accompanied by a medium-frequency alarm sound.

## Functional limitations

The following situations may cause LDA to fail to operate as expected or

automatically exit, including but not limited to:

- The vehicle passes through curves with excessive curvature, such as high-speed ramps.
- The lane lines are unclear, worn, missing, intersected or shaded by other vehicles, buildings or landscapes.
- Pass through road sections without lane lines, such as non-standardized roads, intersections and construction areas.
- Road sections passing through special lane lines, such as deceleration prompt line and traffic flow guide line.
- Areas with unclear lane division, such as lane line converge or diverge, highway ramps, urban intersections and left-turn waiting areas.
- The pavement has edges or other high-contrast lines rather than lane lines, such as pavement joints and kerbs.
- The lane line cannot be identified or is incorrectly identified due to height change, such as uphill and downhill.
- The lane line cannot be identified or is incorrectly identified due to light reasons, such as reflection of the lane line caused by strong illumination, poor visibility or insufficient lighting caused by bad weather and night.
- The distance between lane lines on both sides is too wide or narrow.

The following situations may cause LDA to fail to operate as expected or automatically exit due to ADAS camera recognition obstacles, including but not limited to:

- The installation position of the ADAS camera is changed.

## Comfortable Driving

- ADAS camera is blocked or dirty.
- Reduced identification ability at night.
- Dim surrounding environments, such as at dawn, dusk, at night, in tunnels.
- Sudden changes in the brightness of the surrounding environments, such as tunnel entrances or exits.
- Large shadows cast by buildings, landscapes, or large vehicles.
- The ADAS camera is exposed to direct light.
- Severe weather like rain, snow, fog, and haze.
- Exhaust, water spray, snow or dust raised by the vehicle ahead.
- Water, dust, micro scratches, grease, dirt, wipers, freeze, snow, etc. on the windscreen in front of the ADAS camera.
- Wet road surface.

It is not recommended to use lane departure assist under special or complex road conditions, which may cause LDA to fail to operate as expected or automatically exit, including but not limited to:

- There are water, mud, potholes, ice and snow roads, and roads with speed bumps and obstacles.
- Traffic conditions with more pedestrians, bicycles or animals.
- There are complex and changeable traffic conditions, such as busy intersections, expressway ramps and crowded roads.
- Winding roads and sharp turns.
- Uphill and downhill roads.
- Bumpy roads.
- Narrow roads.
- Tunnel entrance and exit.

- Non-standardized roads.
- Roads without medians.



### Caution

- When the turn signal is turned on and the vehicle departs to the corresponding side, LDA will not remind the driver or control the vehicle.
- When LDA controls the direction, the steering wheel will rotate. You can turn the steering wheel to actively take over the vehicle.
- The display on the combination instrument is only for reference and cannot fully reflect the real traffic conditions. Please do not rely on the display content of the instrument cluster.



### Warning

- LDA only works when both hands are on the steering wheel while driving. If it is detected that the driver does not hold the steering wheel with both hands for a period of time, it will automatically exit the activation state. After the driver holds the steering wheel with both hands and meets the function activation conditions, the function will be activated again.
- As a driving assistance function, LDA cannot cope with all traffic, weather and road conditions. The LDA is for information only and does not replace your visual inspection.
- LDA can only provide certain steering assistance, but cannot control the vehicle speed.



## Warning

- LDA steering force is limited, which can only provide slight corrective steering assistance and cannot guarantee to completely prevent the vehicle from deviating from the lane. Therefore, do not rely on LDA to control the direction. The driver should always be prepared to increase the steering force, especially in curves. If you need to turn, make a U-turn or pass through winding and sharp turns, please take over the steering wheel immediately.
- The driver must always pay attention to the traffic conditions and road environment, and decide whether to use LDA on the premise of ensuring safety. When using LDA, the driver shall be ready to take over the vehicle at any time if he/she finds that the traffic conditions, road environment or vehicle conditions are not suitable for using this function, or there are other unsafe factors. The driver always bears the ultimate responsibility for keeping the vehicle running safely in the lane and complying with local traffic laws and regulations.
- Please observe local road traffic safety regulations when starting LDA, including but not limited to regulations on vehicle running speed.
- LDA cannot continuously control the vehicle direction, that is, it cannot keep the vehicle in the middle of the lane all the time.

## Cruise assist\*

During driving, the vehicle keeps running in its own lane at the cruising speed or cruise distance set by the driver.

### Adaptive cruise control (ACC)

ACC includes cruise control, fixed distance vehicle-following and vehicle-following start/stop. The vehicle can run at the cruising speed set by the driver, or follow a front vehicle to run, stop or start according to the cruising distance set by the driver.

ACC is mainly suitable for long-distance driving on dry and smooth standardised roads, such as highways, freeways, and long straight arterial roads.

### Button description

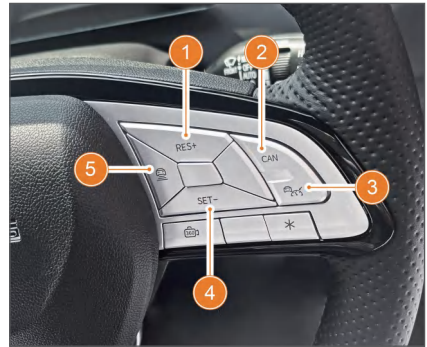

#### 1. Cruise control resume/acceleration button

**Resume:** After the ACC deactivates, press this button to reactivate to deactivate from the front speed and distance driving.

**Acceleration:** When ACC is activated, press this button to increase the cruise speed. Short-press this button to increase the cruise set speed by 1 km/h. Long-press this button to continuously increase the cruise set speed by 5 km/h until the button is released.

### 2. Cruise control pause button

When ACC is activated, you can pause the cruise by pressing this button.

### 3. Cruise control button

Press this button to activate or exit ACC.

### 4. Deceleration button

When ACC is activated, press this button to reduce the cruising speed. Short press this button to reduce the cruise set speed by 1 km/h; long press this button to continuously reduce the cruise set speed by 5km/h until the button is released.

### 5. Following distance adjustment button

When ACC is activated, the cruise distance (following distance) can be adjusted by pressing this button.

### Activate ACC

ACC can be activated if all of the following conditions are met:

1. The vehicle speed does not exceed 140 km/h.
2. The ADAS camera functions normally and has a clear field of vision.
3. All components of ACC function normally.
4. The vehicle meets all safety conditions. For example, the driver fastens the seat belt, all doors are closed, the vehicle is in Gear D, and the driver does not depress the brake pedal; the anti-lock brake system, traction control system and electronic stability control system are not triggered; the traction control system and electronic stability control system are not manually disabled.

When ACC can be activated, the instrument cluster ACC cruise control ON (not activated) indicator lights up. At this time, press the cruise button, ACC is activated and enters the working state, and the ACC cruise activation indicator

lights up:

1. When there is no vehicle ahead, ACC can be activated within the speed range of 15 to 130 km/h.
2. When there is a car ahead, ACC can be activated within the speed range of 0 to 130 km/h.
3. When the vehicle speed is lower than 30 km/h, 30 km/h will be automatically set as the cruise speed; when the vehicle speed is higher than 30 km/h, the current vehicle speed can be set as the cruise speed.

After the function is activated, the driver can release the accelerator pedal and ACC will keep the set cruising speed: If there is a vehicle ahead, ACC will automatically adjust the speed according to the speed of the front vehicle and the cruising distance, and the maximum speed shall not exceed the cruising speed. If there is no vehicle ahead, ACC will adjust the vehicle speed until it reaches the cruising speed.

After ACC is activated, you can step on the accelerator pedal at any time to take over the vehicle in a short period of time. At this time, ACC will no longer respond to the target front vehicle, and the vehicle will be completely under the control of the driver; when the accelerator pedal is released, the vehicle will return to the cruising speed.

When ACC actively accelerates, the accelerator pedal will not move; when ACC decelerates, the brake pedal will move.

### Exit ACC

When any of the following situations occurs, ACC will exit the activation state:

- Press the cruise button.
- Press the brake pedal.

- Depress and hold the accelerator pedal to actively take over the vehicle for about 1 min.
- The vehicle follows and stops for more than 3 minutes.

In addition, when ACC does not meet the activation conditions, it will exit automatically. The driver should take over the vehicle's brake pedal, accelerator pedal and steering wheel immediately after ACC exits to control the speed and direction of the vehicle.

After ACC is deactivated, the vehicle may decelerate due to energy recovery braking and no longer keep the set distance from the front vehicle.



### Warning

- ACC may exit unexpectedly due to unforeseen circumstances. Please always pay attention to the traffic conditions and road environment, and be ready to take over the vehicle at any time.
- After the ESC system is turned off, ACC will be automatically deactivated. The driver should take over the vehicle immediately after ACC exits.

### Vehicle speed adjustment

When ACC is activated:

1. Short press the cruise resume/acceleration button or deceleration button to increase or decrease the cruising speed by 1 km/h.
2. Press and hold the cruise resume/acceleration button or deceleration button, and the cruising speed will continue to increase or decrease by 5 km/h.
3. The maximum set speed of ACC is 130 km/h.

4. The minimum set speed of ACC is 30 km/h, but it can follow and stop to 0 km/h.



### Warning

The above maximum speed is the maximum speed supported by ACC in theory. Please observe road traffic safety regulations when using the ACC, including but not limited to regulations on vehicle running speed.

### Distance adjustment

When ACC is in standby mode or activated, press the distance adjustment button to set the following distance. There are 4 levels of adjustable following distance. The default is level 4 (the farthest level).



### Caution

- When the following distance is set close, ACC driving behavior is more intense and may cause discomfort.
- The following distance is set according to the safety and comfort of the vehicle, and there will be a certain distance from the front vehicle in specific scenarios.



### Warning

The driver is responsible for ensuring a safe following distance at all times. Do not rely entirely on ACC to maintain this distance.

# Comfortable Driving

## Instrument cluster information

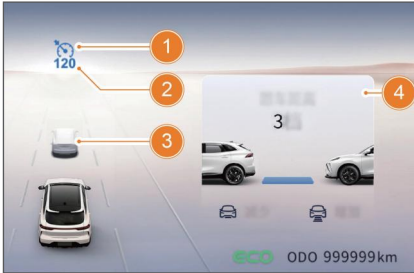

1. ACC cruise state indicator

No indicator appears: ACC is not turned on yet or cannot be turned on if the conditions are not met.

 : ACC is in the waiting state and can be activated by pressing the cruise button.

 : ACC is activated and enters the working state.

2. Set cruise speed

3. Following target front vehicle

4. Following distance



### Caution

The display on the Instrument cluster is only for reference and cannot fully reflect the real traffic conditions. Please do not rely on the display content of the Instrument cluster.



### Warning

- ACC cannot guarantee that the target can be accurately identified in all situations. If it is found that the situation displayed on the instrument cluster is inconsistent with the actual situation (for example, there is a vehicle ahead but it is not displayed or there is no vehicle ahead but it is displayed), please take over the vehicle immediately.



### Warning

- If you find a danger, do not wait for an alarm on the Instrument cluster interface before taking action. Please take over the vehicle immediately.

## Following start/stop

When ACC follows and stops with the front vehicle:

1. If the front vehicle starts, ACC will automatically follow and start. You need to always confirm that the surrounding environment is safe to avoid collision accidents.

2. After following and stopping with the front vehicle for more than 3 seconds, you need to confirm that the surrounding environment is safe, press the cruise resume/acceleration button or step on the accelerator pedal to reactivate ACC, and the vehicle will follow and start.

3. After about 3 minutes, ACC will exit. After ACC follows and stops with the front vehicle, ACC will follow and start only when the starting distance of the front vehicle exceeds about 4 m.



### Warning

- ACC cannot detect other traffic participants in all situations and may be invalid, malfunction or be delayed due to several factors.
- The driver must always pay attention to the traffic conditions and road environment. Do not rely on ACC for automatic following and starting; otherwise, personal injury or vehicle damage may be caused.

## Functional limitations

The following situations may cause ADAS camera recognition obstacles, affect ACC performance, and even cause ACC to exit, including but not limited to:

- The installation position of the ADAS camera is changed.
- ADAS camera is blocked or dirty.
- Reduced identification ability at night.
- Dim surrounding environments, such as at dawn, dusk, at night, in tunnels.
- Sudden changes in the brightness of the surrounding environments, such as tunnel entrances or exits.
- Large shadows cast by buildings, landscapes, or large vehicles.
- The ADAS camera is exposed to direct light.
- Severe weather like rain, snow, fog, and haze.
- Exhaust, water spray, snow or dust raised by the vehicle ahead.
- Water, dust, micro scratches, grease, dirt, wipers, freeze, snow, etc. on the windscreen in front of the ADAS camera.
- Wet road surface.

It is not recommended to use ACC under special or complex road conditions, which may affect the performance of ACC and even cause ACC to exit, including but not limited to:

- Waterlogged, muddy, potholed, icy and snowy roads, roads with speed bumps or obstacles.
- Traffic conditions with more pedestrians, bicycles or animals.
- There are complex and changeable traffic conditions, such as busy intersections, expressway ramps and crowded roads.

- The road is winding and sharply turning.

- Uphill and downhill roads.
- Bumpy roads.
- Narrow roads.
- Tunnel entrance and exit.
- Non-standardized roads.
- Roads without medians.

Under the following conditions, if the relative speed with a front vehicle is too high, ACC may have limited control ability, resulting in failure to keep distance in time. This includes, but is not limited to:

- The front vehicle suddenly manoeuvres (such as sudden turning, acceleration and deceleration)
- Other vehicles suddenly drive in or out of the front of the vehicle.
- The vehicle suddenly drives behind the front vehicle.
- The vehicle rushes towards a stationary or slow-moving target ahead at high speed.

Sufficient braking force may not be obtained in the following situations. This includes, but is not limited to:

- The braking function cannot be fully functional (such as brake parts are too cold, overheated, wet).
- Improper vehicle maintenance (such as excessive wear of brakes or tyres, abnormal tyre pressure).
- The vehicle is running on special roads (such as uphill and downhill, waterlogged, muddy, potholed, icy and snowy roads).

Only vehicles that meet the conditions will be responded to by ACC. The following targets are not guaranteed to

## Comfortable Driving

be identified and may be responded to, including but not limited to:

- Side-crossing vehicle.
- Oncoming traffic.
- Bicycles, motorcycles, tricycles.

The following targets will not be responded to, including but not limited to:

- People, animals.
- Traffic lights, walls.
- Barricades (cones, etc.).
- Other non-vehicle objects.



### Caution

ACC may miss stationary or slow-moving vehicles, and cannot guarantee to identify special vehicles. Special caution shall be paid especially at night. Such as vehicles with obstructions at the rear, vehicles with irregular shapes, and vehicles whose vertical plane at the rear is lower than a certain height.

The following situations could lead to ACC recognising and responding too late due to the target not being directly ahead, including but not limited to:

- ACC will not respond to targets in the blind spot of sensors. For example, the corner and side blind spots of the vehicles cannot be detected.
- When approaching or turning through the road, a target may be mistakenly selected or missed, resulting in unexpected acceleration and deceleration of the vehicle.
- When on a slope, the target may be lost, or the distance from the front vehicle may be misjudged; When going downhill, the driving speed will increase, resulting in exceeding the cruise speed.

- When only part of the vehicle body in the adjacent lane drives into the front of the vehicle (especially large vehicles such as buses and trucks), it may not be able to identify and respond, and you need to take over in time.

- When the vehicle suddenly drives behind the front vehicle, or when another vehicle suddenly drives into or out of the front of the vehicle, it may not be able to identify the target in time and you need to take over in time.



### Caution

- The ACC will occasionally accelerate when there is no need to accelerate or the driver does not intend to accelerate, which may be caused by the change or loss of the following target (especially in turning or lane changing).
- The ACC occasionally performs braking when it is not necessary or the driver does not intend to brake. This may be caused by the detection of vehicles, objects or stationary targets changing or missing in adjacent lanes (especially during turning or lane change).



### Warning

- The ACC system is a comfort function rather than an anti-collision function, so its maximum deceleration is limited and less than the maximum deceleration that can be requested during automatic emergency braking and driving. Therefore, do not rely on the ACC system to fully decelerate the vehicle to avoid collision.



## Warning

- As a driving assistance function, ACC cannot cope with all traffic, weather and road conditions. Please do not completely rely on this function.
- ACC can only control the vehicle speed, but not the driving direction.
- The driver must always pay attention to the traffic conditions and road environment, and decide whether to use ACC on the premise of ensuring safety. When using ACC, the driver shall be ready to take over the vehicle at any time if he/she finds that the traffic conditions, road environment or vehicle conditions are not suitable for using this function, or there are other unsafe factors. The driver always bears the ultimate responsibility for keeping a proper distance and speed and complying with current traffic laws and regulations.
- When the relative speed between the vehicle and the front vehicle is greater than 50 km/h, if the front vehicle is stationary or moving slowly, there is a risk that ACC cannot stop the vehicle. To ensure safety, please immediately exit ACC and take over the vehicle when the above situation occurs. Do not try to use ACC to brake a stationary vehicle or follow and stop with the front vehicle in the above situation.

## Intelligent high beam control (IHC)\*

During driving, the vehicle automatically switches between high and low beams according to the driving environment, which includes ambient light factors such

as vehicles and street lights.

## Switch Settings

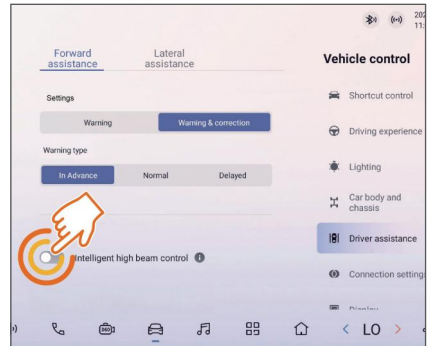

Tap [Vehicle control]-[Driver assistance]-[Forward assistance] in turn in the bottom navigation bar of the multimedia display screen to enable or disable [Intelligent high beam control].

## Function Activated

The IHC can be activated if all of the following conditions are met:

1. The multimedia display screen IHC switch is turned on.
2. The vehicle speed is greater than 30 km/h.
3. Low beam on.

## Function triggering

Turn on the high beam: It is dark outside and there are no other traffic participants ahead.

Turn off the high beam: It is bright outside or there are other traffic participants ahead.

## Function Exit

The IHC system function will be deactivated if any of the following conditions are met:

- The low beam is turned off.
- The IHC switch on the multimedia display screen is turned off.
- The vehicle speed drops below 25 km/h.

- The light control is set to overtaking light or high beam.

### Functional limitations

- Rain, ice, snow, dense fog and dirt may cause performance degradation of the IHC system.
- The IHC system may not work normally when the light of the vehicle ahead is blocked (such as the crash barrier).
- When there are highly reflective objects near the road (such as traffic signs), the IHC system may not work normally.
- The IHC system may not work normally due to the instability of the vehicle body when the vehicle is running on a bad road section (such as slippery road, slope or pit, sharp turn, etc.).



#### Warning

- The intelligent high beam control is an auxiliary function and cannot work in all driving situations or traffic, weather and road conditions. The driver shall always take the ultimate responsibility for ensuring safe driving and comply with applicable laws and road traffic rules.
- Extreme weather such as heavy rain, heavy snow and dense fog or camera being blocked may affect the normal use of this function. Please drive carefully.

## Side-rear driver assistance\*

The side-rear driver assistance system can detect rear vehicles or vehicles in adjacent lanes via sensors on both sides of the rear bumper. If there is a collision risk, the system will give an alarm to remind the driver to drive safely.

The main functions of the side-rear driver assistance system include:

1. Lane change assist
2. Door opening warning
3. Rear crossing warning
4. Rear collision warning

### Sensors

The radar sensor is located inside the rear bumper.



#### Caution

- The backward radar sensor is installed on the inner side of the rear bumper. To avoid affecting the performance of the sensor, it is strictly forbidden to spray paint or install surrounds on the bumper without permission.
- Improper maintenance or modification of the vehicle may cause sensor misalignment, affecting the normal operation of the side-rear driver assistance system. Therefore, it is recommended that you contact the Forthing Service Station.
- Please turn off the side-rear driver assistance system when towing other vehicles.
- Please keep both sides of the rear bumper clean, and do not paste any objects and have any ice, snow, mud and other foreign objects, so as not to affect the normal work of the sensor.



## Warning

- When the radar cannot work normally, the functions that rely on the radar to provide detection information will be limited, resulting in abnormal operation of these functions. At the same time, the radar has limited detection range and cannot detect targets beyond the detection limit.
- When the radar is in a poor environment, it will affect the normal operation of the radar. In addition, when the target detected by the radar is in an abnormal state, it will also affect the detection results of the radar.

The following conditions will cause the radar to fail to detect the target, detect the delay or detect the error:

- Unfavourable weather conditions (such as heavy rain, heavy snow and dense fog).
- The radar surface or the inner and outer sides of the rear bumper in the radar irradiation area are attached by foreign objects such as ice, snow, water, dust, etc.
- The objects detected by radar are attached with substances that absorb electromagnetic waves, such as snowflakes, foam and cotton objects.
- There are objects near the vehicle that can cause incorrect reflection of electromagnetic waves, such as: iron construction fences, irregular guardrails, continuous speed bumps with metal parts and other strong reflective objects around.
- The vehicle bumps or shakes due to uneven road or other reasons.

- The volume of the detected object is too small.

- There is electromagnetic interference of the same frequency around.

The above examples, warnings and restrictions do not cover all situations that affect the normal operation of the radar sensor.

To protect the radio astronomy industry working in the same frequency band, vehicles equipped with automotive radars must comply with local laws and regulations when operating in the relevant area.

## Warning light



The warning lights are located at the mirror housings of the left and right exterior rearview mirrors.



## Warning

Please do not attach any objects on the warning lights to avoid affecting the system's alarm function.

# Comfortable Driving

## Blue Change Assist (LCA) system

LCA system includes blind spot detection system and lane change alert, capable of detecting vehicles approaching from the rear side and providing advance warning information to prevent collisions.

### Switch Settings

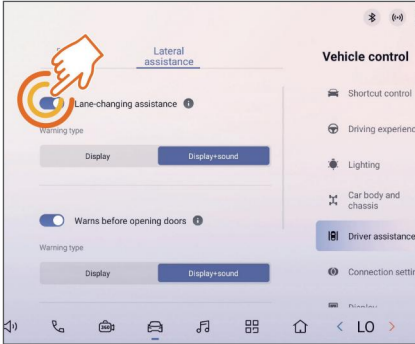

Tap [Vehicle control]-[Driver assistance]-[Lateral assistance] in turn in the bottom navigation bar of the multimedia display screen to enable or disable [Lane-changing assistance]. It is enabled by default.

After the switch is turned on, you can choose the warning type as [Display] or [Display + sound]. When the vehicle speed is greater than 15 km/h, the function will be activated to monitor the conditions behind the side of the vehicle in real time.

## Lane change assist (LCA) range

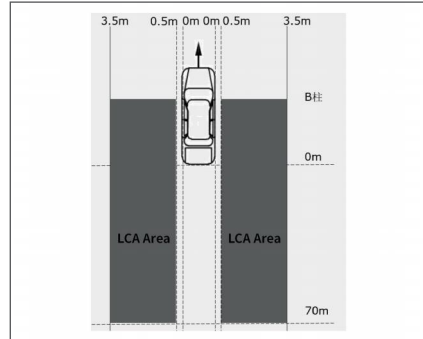

The LCA monitoring area is 3.5 meters outside the vehicle and about 70 meters behind it, as shown in the figure. The shaded area is the early warning area, which is bilaterally symmetrical.

### Function triggering

**Level 1 alarm:** The target approaching the vehicle triggers a level 1 alarm, and the warning light of the exterior rearview mirror on the same side is always on.

**Level 2 alarm:** When the target approaches the vehicle, the level 1 alarm will be triggered. When the turn signal on the same side is turned on, the level 2 alarm will be triggered. The warning light of the exterior rearview mirror on the same side will flash, accompanied by an audible alarm.



### Caution

When the ambient noise is loud, for example, the interior audio volume is too loud or the exterior is too noisy, the alarm sound may not be heard.

### Function Exit

The function is deactivated if any of the following conditions are met:

- Lane-changing assistance switch on the multimedia display screen is turned

off.

- Power off the vehicle.
- The vehicle is not in D gear.
- The vehicle speed is less than 12 km/h.
- The system fault occurs.

### Functional limitations

When the vehicle is driving on a road with large curves, wide lanes or uneven surfaces, the LCA system may not be able to give an alarm to the vehicle driving in the lane next to it.

The LCA system may give false alarms in the following cases:

- When driving close to a guardrail.
- When driving on a bridge, under a bridge or in a tunnel.
- When driving beside shrubs, trees, etc.
- When there are electric poles, street lights or concrete low walls beside the driving road.
- When driving near construction areas such as factory buildings, ports, etc.
- When driving on urban roads or turning at multi-lane intersections.
- There is a large moving metal object in the blind spot.

The above warnings and limitations do not address all situations that may interfere with the LCA system. There are many factors that can lead to LCA system failure. In order to avoid collisions, the driver needs to be vigilant when driving the vehicle and always pay attention to the road conditions so as to change lanes when it is safe to do so.



### Caution

- The LCA system is an auxiliary driving function and does not work in all cases.
- The display on the combination instrument is only for reference and cannot fully reflect the real traffic conditions. Please do not rely on the display content of the instrument cluster.
- The LCA system cannot replace safe driving and the use of interior and exterior rearview mirrors.



### Warning

- If this function cannot work normally due to vehicle collision, scratch, radar failure or abnormality, please contact a Forthing service station.
- Please keep the place where the bumper radar is installed and the surrounding area clean. If it is covered with dirt, ice and snow, metal plates, tapes, labels or leaves, its performance will be affected and normal alarm cannot be given.
- If there is no fault prompt and the radar function is abnormal for a long time, please contact an authorized Forthing service station.
- The system only warns of detected vehicles, large motorcycles or objects, so there may be a certain degree of delay and even no warning for other targets including pedestrians, bicycles or skateboards.
- Do not use this function in trailer mode.

# Comfortable Driving



## Warning

- The system does not warn of stationary objects. False alarms may be generated for some metal protective fences, green belts and concrete walls.
- Extreme weather conditions such as heavy rain, snow and fog may affect the radar performance. Please drive carefully.

## Door Open Warning (DOW)

When the vehicle is stationary, the DOW system can detect vehicles, cyclists or pedestrians approaching the vehicle from the rear. When it detects that a target is approaching and the driver or passengers open the door, the DOW system will give early warning information.

### Switch Settings

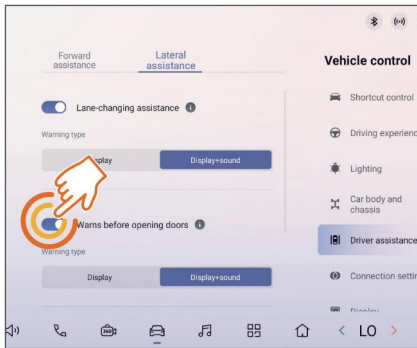

Tap  [Vehicle control]-[Driver assistance]-[Lateral assistance] in the bottom navigation bar of the multimedia display screen to turn on or off [Warns before opening doors]. It is turned on by default.

After the switch is turned on, you can choose the warning type as [Display] or [Display + sound]. When the vehicle is powered on and the speed is 0 km/h, this

function will be activated to monitor the conditions behind the side of the vehicle in real time.

### Door opening warning (DOW) range

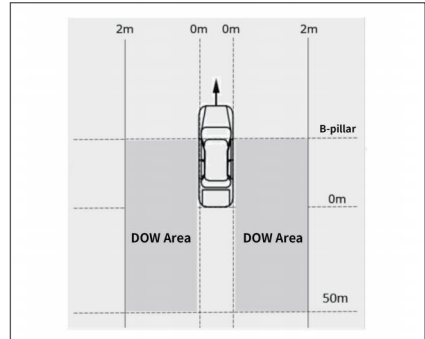

The alarm area of the DOW system is from 0 m to 2 m horizontally on the left and right sides of the vehicle, and from the B-pillar position to 50 m behind the rear of the vehicle longitudinally, as shown in the figure. The shaded area is the early warning area, which is bilaterally symmetrical.

### Function triggering

**Level 1 alarm:** The target approaching the vehicle triggers a level 1 alarm, and the warning light of the exterior rearview mirror on the same side is always on.

**Level 2 alarm:** Level I alarm is triggered when the target approaches the vehicle, and level II alarm is triggered when the door on the same side is opened. The warning light of exterior rearview mirror on the same side flashes with audible alarm.



## Caution

When the ambient noise is loud, for example, the interior audio volume is too loud or the exterior is too noisy, the alarm sound may not be heard.

## Function Exit

The function is deactivated if any of the following conditions are met:

- The multimedia display screen Warns before opening doors switch is turned off.
- The vehicle speed is greater than 0km/h.
- The vehicle is powered off for more than 3 minutes.
- The system fault occurs.

## Functional limitations

The DOW system is not always able to work under various circumstances, and various reasons may lead to unnecessary, inappropriate and invalid warnings or omitted warnings, such as:

- The radar is limited.
- Smaller targets or stationary targets.
- The target speed is too fast or there is steering behaviour. For example: when the target vehicle changes lane to directly behind the subject vehicle, or other vehicles suddenly change lane directly behind the subject vehicle and appear in the detection area.
- Other vehicles and cyclists directly behind the vehicle.
- The vehicle stays at a corner or beside a wall.

The above warnings and restrictions do not address all situations that may interfere with the door opening warning. There are many factors that can lead to the failure of door opening warning. In order to avoid the risk of scratching when opening the door, please remember to observe whether the door opening environment is safe and suitable.



## Caution

- The DOW system is effective only when the vehicle is stationary, and this function will not work when the vehicle is moving.
- Even when the vehicle is stationary, the DOW system cannot work under all circumstances and cannot replace the visual observation of the driver and passengers and the functions of the interior and exterior rearview mirrors. Please do not rely too much on the DOW system.
- The DOW system is designed to remind the driver and passengers to pay attention to the environmental safety when opening doors. Limited by the performance of sensors and the complexity of traffic environment, unnecessary alarms or no alarm may be given. To ensure personal safety, the driver and passengers have the responsibility to actively observe the door-opening environment before getting off the vehicle.



## Warning

- If this function cannot work normally due to vehicle collision, scratch, radar failure or abnormality, please contact a Forthing service station.
- Please keep the place where the bumper radar is installed and the surrounding area clean. If it is covered with dirt, ice and snow, metal plates, tapes, labels or leaves, its performance will be affected and normal alarm cannot be given.



## Warning

- If there is no fault prompt and the radar function is abnormal for a long time, please contact an authorized Forthing service station.
- The system only warns of detected vehicles, large motorcycles or objects, so there may be a certain degree of delay and even no warning for other targets including pedestrians, bicycles or skateboards.
- The system does not warn of stationary objects. False alarms may be generated for some metal protective fences, green belts and concrete walls.
- Extreme weather conditions such as heavy rain, snow and fog may affect the radar performance. Please drive carefully.
- Do not use this function in trailer mode.

## Rear cross traffic alarm (RCTA)

When the vehicle is reversing, the RCTA system can detect vehicles, cyclists or pedestrians crossing behind the vehicle. When the system detects that a target is approaching and there is a risk of collision with the vehicle, it will issue an early warning message.

## Switch Settings

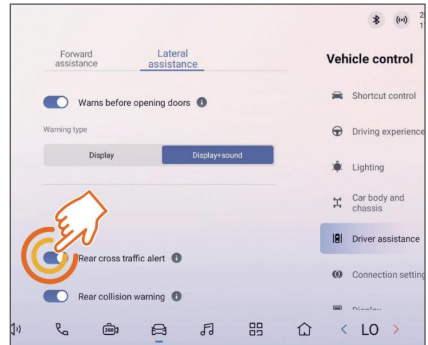

Tap [Vehicle control]-[Driver assistance]-[Lateral assistance] in the bottom navigation bar of the multimedia display screen to turn on or off [Rear cross traffic alert].

After the switch is turned on, when the vehicle is in R gear and the speed is less than or equal to 15 km/h, the function will be activated to monitor vehicles crossing behind the vehicle in real time.

## Rear cross traffic alert (RCTA) range

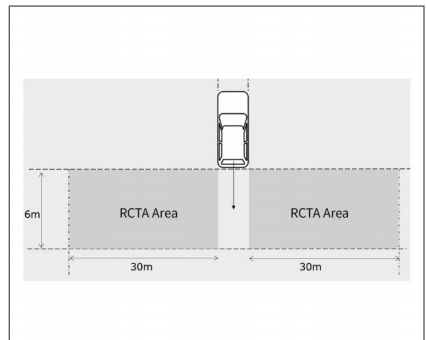

The alarm area of RCTA system is from 0m to 30m laterally on the left and right rear sides of the vehicle, and from the rear to 6 m rearward, as shown in the figure. The shaded area is the early warning area, which is bilaterally symmetrical.

## Function triggering

When a target approaches the rear of the vehicle during reversing, the exterior rearview mirror warning light flashes, accompanied by sound prompt and parking assist interface display.



### Caution

When the ambient noise is loud, for example, the interior audio volume is too loud or the exterior is too noisy, the alarm sound may not be heard.

## Function Exit

The function is deactivated if any of the following conditions are met:

- Backward crossing warning switch on the multimedia display screen is turned off.
- The vehicle is not in "READY" status.
- The vehicle is not in R gear.
- Vehicle speed is more than 15 km/h.
- The system fault occurs.

## Functional limitations

The RCTA system does not respond to targets in the radar blind spot and cannot detect vehicles behind it through obstacles or parked vehicles. The RCTA system does not always work in all situations. There are many reasons that may cause the system to have unnecessary, untimely or invalid warnings and missing warnings, such as:

- The radar is limited.
- The speed of the detected object is too high.
- There is a large moving metal object in the blind spot.

The following conditions may cause obstacles to radar identification and affect the performance of the RCTA system,

including but not limited to:

- The radar is misaligned or blocked, or covered with soil, ice and snow, metal plates, tapes, labels, leaves, etc.
- Radar or surrounding areas are impacted due to vehicle collisions, scratches, etc.
- Extreme weather conditions such as rain, snow, fog and haze may affect radar performance.
- Due to the limitation of radar identification target characteristics, under rare special circumstances, false alarms may be generated for some metal protective fences, green belts, and concrete walls

The following targets are not guaranteed to be identified and may be responded to, including but not limited to:

- Motorcycle.
- Battery cart.
- Three-wheeler.
- Person.

The following targets will not be responded to, including but not limited to:

- Animals.
- Bicycle.
- Oncoming/same-direction vehicles.
- Other non-vehicle objects.

The above warnings and restrictions do not address all situations that may interfere with RCTA system. Many factors may cause the malfunction of RCTA system. To avoid collision, the driver shall keep vigilant and pay attention to road conditions at all times during driving so as to reverse safely.



## Warning

- The RCTA system is a driver assistance function and cannot cope with all traffic, weather and road conditions. Due to various factors, it may become invalid, improper or untimely.
- The RCTA system is for information only and does not replace your visual inspection. The driver must always pay attention to the traffic conditions and road environment, and decide whether to use the RCTA system on the premise of ensuring safety. The driver always bears the ultimate responsibility for driving safely and complying with current traffic laws and regulations.
- RCTA is only for warning and will not stop the vehicle. Do not rely on this function to avoid collision or reduce the impact of collision.
- The RCTA system cannot replace safe driving and the functions of interior and exterior rearview mirrors.

## Rear Collision Warning (RCW) system

When the vehicle is driving and there is a risk of collision between the rear vehicle and the ego vehicle, the system will issue an early warning message.

## Switch Settings

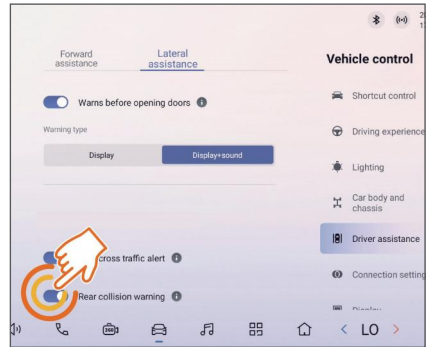

Tap [Vehicle control]-[Driver assistance]-[Lateral assistance]-[Lateral assistance] in the bottom navigation bar of the multimedia display screen to turn on or off [Rear collision warning].

## Rear collision warning range

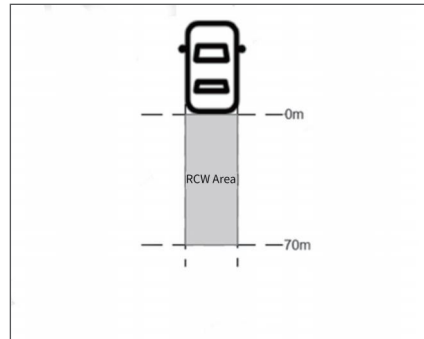

The alarm area of the RCW system is about 70 meters from the rear of the vehicle to the rear, as shown in the figure. The shaded area is the warning area.

## Function triggering

When the moving target is located in the warning area of RCW and it is detected that there is a collision risk due to too close vehicles behind the vehicle, an alarm will be triggered. The text alarm/assisted driving display area on the instrument cluster will be marked red behind the vehicle, the exterior rearview

mirror alarm lights will flash, and the hazard warning lights will light up.



## Caution

The display on the instrument cluster is only for reference and cannot fully reflect the real traffic conditions. Please do not rely on the display content of the instrument cluster.

### Function Exit

The function is deactivated if any of the following conditions are met:

- Backward collision warns switch on the multimedia display screen is turned off.
- The vehicle is not in "READY" status.
- The vehicle is in R gear.
- The system fault occurs.

### Functional limitations

The RCW system does not respond to targets in the radar blind spot and cannot detect vehicles behind it through obstacles or parked vehicles. The RCW system does not always work in all situations. There are many reasons that may cause the system to have unnecessary, untimely or invalid warnings and missing warnings, such as:

- The radar is limited.
- The speed of the detected object is too high.
- There is a large moving metal object in the blind spot.

The following conditions may cause obstacles to radar identification and affect the performance of RCW, including but not limited to:

- The radar is misaligned or blocked, or covered with soil, ice and snow, metal plates, tapes, labels, leaves, etc.

- The radar or the surrounding area is hit due to vehicle collision or scratch.

- Extreme weather conditions such as rain, snow, fog and haze may affect radar performance.

- Due to the limitation of radar identification target characteristics, under rare special circumstances, false alarms may be generated for some metal protective fences, green belts, and concrete walls.

The following targets are not guaranteed to be identified and may be responded to, including but not limited to:

- Motorcycle.
- Battery car.
- Tricycle.

The following targets will not be responded to, including but not limited to:

- People, animals.
- Bicycle.
- Oncoming/same-direction vehicles.
- Other non-vehicle objects.

The above warnings and restrictions do not address all situations that may interfere with the RCW system. Many factors may cause the malfunction of RCW. To avoid collision, the driver shall keep vigilant and pay attention to road conditions at all times during driving so as to reverse safely.



## Warning

- As a driving assistance function, RCW system cannot cope with all traffic, weather and road conditions. Due to several factors, it may become invalid, improper or untimely.



### Warning

- The RCW system is for information only and does not replace your visual inspection. The driver must always pay attention to the traffic conditions and road environment, and decide whether to use the RCW system on the premise of ensuring safety. The driver always bears the ultimate responsibility for driving safely and complying with current traffic laws and regulations.
- The RCW system is only for reminding and warning. Please do not rely on this function to avoid collision or reduce the impact of collision.
- The RCW system cannot replace safe driving and the functions of interior and exterior rearview mirrors.

**Daily inspection items ..176****Cleaning and maintenance****.....176**

Exterior maintenance..... 176

Front compartment gutter  
channel ..... 177

Vehicle sealing strip..... 177

Interior maintenance..... 178

**Self-maintenance .....179**

Engine bay..... 179

Layout of engine bay ..... 180

Reducer lubricating oil ..... 181

Coolant ..... 181

Brake fluid..... 182

Windscreen washer fluid . 182

A/C filter ..... 183

12V low-voltage battery ... 183

Tyre..... 184

## Daily inspection items

Item	Inspection contents
Coolant level	Regularly check the coolant reservoir level to see if it is between the lower limit (MIN) and upper limit (MAX) marks.
Brake pedal	Check the brake pedal for its maneuverability before driving each time.
Horn	Check whether the horn is normal before driving each time.
Door	Check if the boot lid and all other doors (including rear doors) can be opened/closed freely and locked firmly.
A/C system	Check the operation of A/C every week.
Washer fluid	Check the remaining amount of washer fluid once a month.
Wiper	Check the wiper once a month.
Brake	Check the brake fluid level once a month.
Tyre	Check the tyre pressure once a month. Check the tread for wear and foreign objects.
12V low-voltage battery	Check the condition of 12V low-voltage battery and the corrosion of terminals once a month.
Front windscreen defroster	Check the air outlet of defroster each time when using the heater and A/C.

Item	Inspection contents
Vehicle lights	Check the condition of headlights, direction indicators, taillights, high-mounted brake lights, and license plate lights once a month.

## Cleaning and maintenance

### Exterior maintenance

Regular and professional maintenance can keep the vehicle in good condition. The following will introduce how to keep the appearance of the vehicle clean, including paint, polishing and wheel cleaning, as well as anti-corrosion measures.

### Vehicle washing

Frequent washing helps preserve the vehicle's appearance. Dust and grit will scratch the paint surface, and leaves and bird droppings will permanently damage the surface finish of the vehicle body. The vehicle body should be washed in a cool place.

Use only solvents and cleaning agents recommended in this manual. While drying the vehicle body, check for any paint peeling or scratches on the vehicle body. If found, repair it with touch-up paint.



### Caution

- Using chemical solvents and strong detergents when cleaning the vehicle will damage the paint, metal and plastic parts and components of the vehicle body. It is recommended to wash the vehicle thoroughly with clean water to remove floating dust.



### Caution

- Check the vehicle body for asphalt, leaves and other dirt, which can be removed with asphalt remover or turpentine, and then wash it with clean water immediately to avoid damaging the surface finish of the vehicle body.
- After cleaning the entire body surface, wipe it dry with a soft towel. Natural drying in the air will cause loss of luster or formation of water stains on the exterior of the vehicle body.



### Caution

When the detergent is used to remove such pollutants as pitch and insects, dewaxing may occur. Therefore, it is necessary to replenish wax in the dewaxing position.

### Waxing

Vehicle waxing is helpful to prevent adhesion of dust and chemicals on the road. Wax the vehicle only after cleaning and drying, and wax it at least once every three months, which helps to protect the body. Please use high quality liquid wax or paste wax. When using, follow the instructions on the packaging.

There are generally two types of products:

#### Body wax

Body wax is a kind of wax applied on the paint surface to protect it from sunlight, air pollution and other damages. It is recommended to wax the body after the new vehicle is used for about half a year.

#### Polishing wax

Polishing wax can repair the paint that has been oxidised or lost its gloss, making it glossy again. Such waxes generally contain soft abrasives and solvents to remove oxidised paint surfaces. If the original gloss cannot be restored after the body wax is applied, polishing wax shall be applied.

### Refinishing

Small cracks and scratches on the paint coating shall be repaired immediately with a special repair film or repair paint to prevent corrosion.

### Aluminium alloy wheel

When cleaning the exterior of the vehicle body, the aluminium alloy wheels of the vehicle shall be cleaned at the same time. After cleaning, rinse the aluminium alloy wheel thoroughly with water.

### Front compartment gutter channel

The front compartment gutter channel is located in front of the front windshield and below the wiper cover plate, which is a very important water passage structure in front of the vehicle.

Check the drainage condition of the front compartment gutter channel every 5,000 km, and try to ensure that the wiper cover plate is clean and tidy, so as to avoid damage to relevant electrical equipment caused by blockage or water accumulation in the gutter channel. In case of blockage and water accumulation, please contact a Forthing service station.

### Vehicle sealing strip

The sealing strip is a rubber sealing part installed on the door or vehicle body. It is one of the parts that ensure

the waterproof sealing of the door and belongs to other parts.

During the use of the vehicle, the surface of the sealing strip shall be cleaned in time to avoid excessive wear caused by gravel or hard particles on the surface of the sealing strip. If the sealing strip surface is found to be worn or damaged, please contact a Forthing service station in time.

### Interior maintenance

#### Carpet

The dust on the carpet should often be cleaned by a vacuum cleaner. Excessive dust accumulation will accelerate the damage of the carpet. Regularly washing carpets with detergent will keep them in better condition.

#### Fabric

The dust and dirt on the textile fabrics would often be cleaned by a vacuum cleaner. Wash with low-temperature neutral soapy water and dry in the air.

#### Vinylon

Use a dust collector to remove the dust and pollutants. Scrub the vinylon with a soft cloth soaked in neutral soapy water to remove stains that are difficult to remove, or use a spray or foam type vinylon cleaner.

#### Leather

Frequently use a vacuum cleaner to remove dust and dirt from the leather, especially at wrinkles and joints. Clean the leather with a soft cloth dipped in clean water, and then wipe it dry with another soft dry cloth. If further cleaning is required, special soap for leather can be used.

#### Window

Use the glass detergent to clean both interior and exterior sides of the windows. Dry all glass and plastic surfaces with a soft cloth or paper towel.

#### Seat belt

If the seat belts are dirty, use a soft brush with neutral warm soapy water to wipe the seat belts clean. Do not use bleaching powder, dye or cleaning solvent because such things will reduce the durability of the seat belt. Do not use the seat belt before it becomes dry.

Too much dust accumulated at the loop at the seat belt outlet will lead to slow contraction of the seat belt. The inner side of the loop can be scrubbed with a clean soft cloth dipped in neutral warm soapy water or isopropyl alcohol. It is not recommended to disassemble the seat belt for cleaning. If the seat belt must be disassembled before cleaning, please contact a Forthing service station.

#### Air freshener

If it is necessary to use air freshener or deodorant in the vehicle, it is recommended to select solid type. Some chemical components contained in liquid air freshener will cause fiber breakage or fading of interior trims and fabrics.

If using liquid air freshener, ensure it is securely fastened to prevent splashing while driving.

#### Corrosion resistance

Salt, dirt and moisture can easily accumulate under the vehicle. Scraping off the vehicle paint or wearing off by stones and sand grains will cause the metal to lose its protection and be exposed, thus causing the vehicle to rust. Common measures to prevent rusting

include:

1. Keep the vehicle clean.
2. Keep the garage dry.
3. Keep the paint and decoration in good condition.
4. Keep regular vehicle maintenance, etc.

## Self-maintenance

### Engine bay

#### Open the bonnet



1. Pull the bonnet opening handle at the lower right side of the dashboard, and the bonnet will pop up slightly.



2. Move the safety lock lever in front of the bonnet leftward with fingers, and lift the bonnet.

#### Close the bonnet



Pull down the bonnet to a height of about 30 cm from the closed position, then push it down to close it, and confirm that it is locked in place. If it is not locked in place, please press the middle part of the front end of the bonnet hard until it is fully closed.



#### Warning

- Make sure that the wipers are retracted before opening the bonnet.
- Before driving, make sure that the bonnet is locked.

### Layout of engine bay

The picture is for reference only, and the actual vehicle shall prevail.

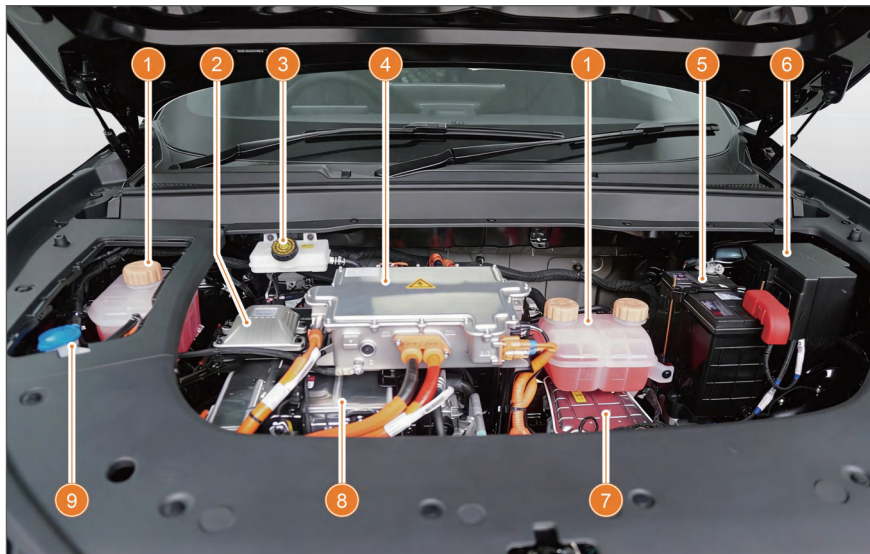

1. Coolant reservoir

2. Electric vehicle

communication controller

3. Brake fluid reservoir

4. PDU

5. 12V low-voltage battery

6. Engine bay fuse box

7. PTC heater combination  
module

8. Power supply two-in-  
one module

9. Washer fluid reservoir

## Reducer lubricating oil

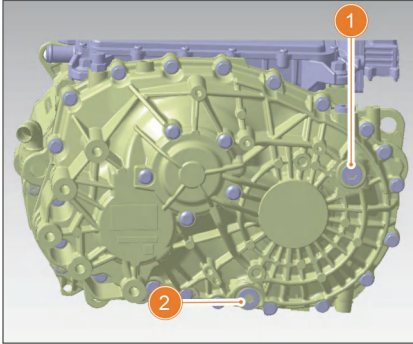

1. Fuel filler
2. Fuel drain outlet

The lubricating oil in the reducer should be replaced according to the mileage specified for maintenance. During replacement, all the oil in the reducer shall be drained and then new lubricating oil shall be injected.

Please choose the reducer lubricating oil suitable for the vehicle. For specific specifications and required filling amount, refer to the "Oil specification and capacity" section in the "Vehicle specifications" chapter.

## Coolant

### Inspection of coolant level



Check whether the coolant level is between the upper limit (MAX) and the lower limit (MIN) scale marks. If it is lower than the lower limit scale line, add coolant to the coolant reservoir to the position between the upper limit and lower limit.

### Coolant refilling

Open the cap of the coolant reservoir to add coolant, and tighten the cap after adding. Do not mix coolants of different brands; otherwise, chemical reactions may easily occur, affecting the service life of the drive motor. Please use the all-season antifreeze coolant specified by Forthing. Please do not replace antifreeze coolant with antifreeze and water.



### Warning

When the drive system is not completely cooled, opening the coolant reservoir cap may cause the coolant to eject, resulting in serious scald. Before opening the coolant reservoir cap, make sure that the drive system has cooled down.

### Replace the coolant

Under normal circumstances, the coolant needs to be replaced every 4 years or 80,000 km, whichever comes first.

### Brake fluid

#### Inspection of brake fluid level

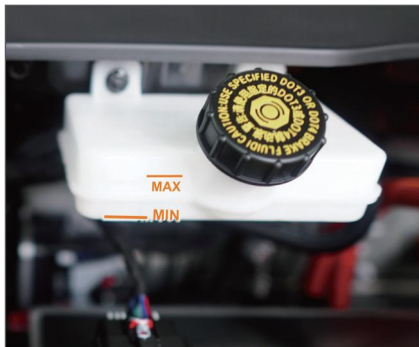

1. Check the fluid level in the reservoir once a month.
2. The fluid level should be between the upper limit (MAX) and lower limit (MIN) scale lines on the reservoir wall. If the fluid level is at or below the lower limit (MIN) mark, please contact a Forthing service station for inspection in time.

#### Replacement of brake fluid

The brake fluid will absorb water in the air. Excessive water content will cause corrosion and damage to the brake system, and the boiling point of the brake fluid will also drop significantly. Please replace the brake fluid in time according to maintenance regulations. Please contact a Forthing service station for brake fluid replacement.



#### Warning

- Be sure to use the brake fluid designated by Forthing or products of the same grade packaged in closed containers approved by Forthing. Do not mix different brake fluids.



#### Warning

- Do not mix the brake fluid with liquids containing mineral oil (engine oil, petrol, etc.), because mineral oil will damage the seals and sealing plugs of the braking device.
- The brake fluid is toxic and should be kept out of the reach of children. Once swallowed by mistake, go to the hospital immediately for examination. The brake fluid is corrosive and is not allowed to contact the paint. Once it overflows on the paint, it needs to be cleaned with plenty of water.
- Brake fluid will damage the skin. If coolant splashes on the skin or eyes accidentally, wash with plenty of water. If you feel uncomfortable, go to hospital immediately.

#### Maintenance and technical requirements of brake fluid

1. The brake fluid shall be replaced every 2 years or 40,000 km, whichever comes first.
2. Brake fluid technology must meet the requirements of relevant performance standards.

#### Windscreen washer fluid

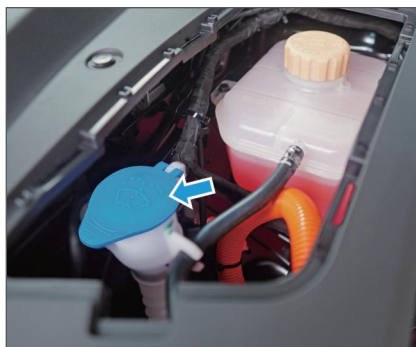

1. The level of the washer fluid reservoir should be checked at least once a month.
2. If water is not sprayed when the wiper spraying function is activated, it indicates that the windscreen washer fluid is insufficient. Add high-quality washer fluid which can improve cleaning ability and prevent freezing in cold weather.
3. If alcohol-based washer fluid is used, the ethanol content of the windscreen washer fluid shall not be higher than 24%.



### Caution

Antifreeze can damage the vehicle's paintwork, and vinegar-based solutions may damage the washer pump. It is recommended to use only the windscreen washer fluid specified by Forthing.

## 12V low-voltage battery



This vehicle is equipped with a maintenance-free 12V low-voltage battery. The 12V low-voltage battery is located in the engine bay, mainly to provide power for vehicle starting. If the 12V low-voltage battery is seriously undervoltage, the vehicle will not be able to start.

### Usage and precautions

1. Do not use electrical devices such as lights, audio and wipers for a long time after the vehicle is powered off.
2. If the vehicle needs to be parked for more than five days, it is recommended to disconnect the negative terminal of the 12V low-voltage battery to prevent the on-board electrical devices from consuming the 12V low-voltage battery.
3. The condition of the 12V low-voltage battery should be checked regularly. Check its terminals for corrosion degree (white or faint yellow powder). In case of corrosion, please contact a Forthing service station.

### Emergency treatment for contacting electrolyte

The electrolyte of 12V low-voltage battery is highly corrosive and toxic. In case of accidental contact, please handle it as

## A/C filter

The A/C filter can remove pollen and dust brought in by the A/C system from the outside.

The A/C filter must be replaced at regular maintenance every 2 years or 20,000 km.



### Caution

- In months when the A/C is not used for a long time or in cold weather, it should be turned on at least once every two weeks for at least 5 minutes each time. This is to prevent the lubrication of parts inside the compressor from deteriorating, so as to keep the A/C in the best operating state.
- If you often drive in areas with heavy smoke and dust, the replacement interval of the filter shall be shortened. It is recommended to replace the A/C filter at a Forthing service station.

## Service and Maintenance

follows:

**Eye contact:** Rinse with water in a cup or other container for at least 15 minutes, and seek medical advice immediately.

**Skin contact:** Take off contaminated clothes, wash skin with plenty of water, and seek medical advice immediately.

**Drink electrolyte by mistake:** Drink water or milk and seek medical advice immediately.



### Warning

- When the vehicle is running normally, the 12V low-voltage battery will produce explosive hydrogen. Sparks or open flames will cause the 12V low-voltage battery to explode. The explosion energy is enough to cause serious injury. Please avoid driving in places where there are sparks and open flames nearby.

- If you need to connect the 12V low-voltage battery to other chargers, disconnect the positive and negative cables to avoid damaging the electrical equipment on the vehicle. Disconnect the negative cable first. During re-connection, it shall be connected last.

## Tyre

In order to drive the vehicle safely, the model and size of the tyres must be suitable, and the tyres must have good tread pattern and appropriate tyre pressure.



### Caution

- Using excessively worn tyres or tyres with insufficient pressure may cause accidents.



### Caution

- You must abide by all manual instructions regarding tyre inflation and maintenance.

## Tyre pressure label



Tyre pressure labels are attached on the vehicle. This label is located below the front passenger side door frame and indicates the air pressure of the front and rear wheels of the vehicle.

For tyre pressure, pay attention to the following points:

1. It is recommended to visually inspect the tyres before driving each time.
2. Check whether the tyre pressure is normal once a month.
3. If necessary, inflate or deflate the tyre to the cold tyre pressure recommended on the label.
4. Check tyre pressure when the tyre is hot (after vehicle running for several kilometres). The pressure reading will be 30~40 kPa higher than that measured in cold state. This is a normal phenomenon. Do not deflate tyres with specified tyre pressure in cold state; otherwise, under-inflation of tyres will be caused.

## Tyre inflation

Make sure that tyres have a proper

pressure, which can provide the best status of maneuverability, tread life and ride comfort.

Underinflated tyres wear unevenly, which will affect handling and increase energy consumption, leading to overheating and air leakage.

Over-inflated tyres will reduce riding comfort, and are more likely to be damaged due to uneven road surfaces, resulting in uneven tyre wear.

### Tyre inspection

Each time you check the tyre inflation state, you should also check the tyres for external injury, puncture by foreign objects and wear. Specific inspections are as follows:

1. Damage or bulge of tyre tread or side. If any of the conditions is found, replace the tyre.
2. Scratches, cracks or fractures on the side of the tyre. If the tyre fabrics or cords are exposed, replace the tyre.
3. If the tread is excessively worn, replace the tyre.

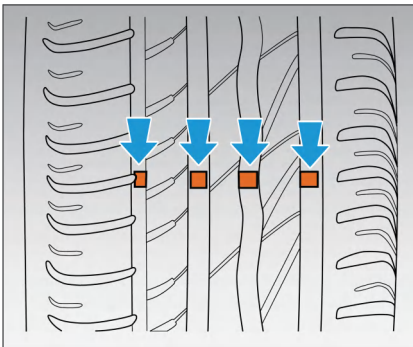

The tyre must be kept in good condition, and the tread pattern on the tyre surface shall be deep enough. The tyre wear degree can be measured by the raised points in the tyre driving belt. If the tread

depth is  $\leq 1.6\text{mm}$ , you must replace the tyre. These tyres have poor grip on wet roads.

### Tyre maintenance

In addition to proper inflation, correct wheel alignment also aids in reducing tyre wear. If you find that the tyres are worn unevenly or you feel some continuous vibration during driving, please contact a Forthing service station.

### Tyre rotation

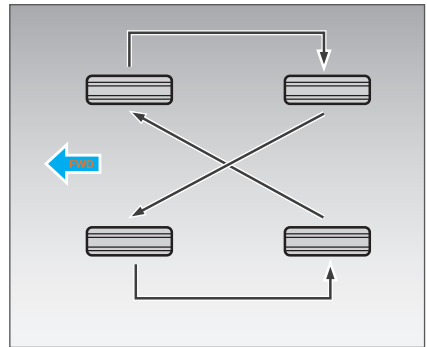

In order to prolong the service life of the tyre and make the tyre wear evenly, the tyre position shall be changed once a year or every 20,000 kilometres. Each time of transposition, the operation shall be carried out according to the method shown in the above figure.

### Specifications of wheels and tyres

Rim specification: 19×7J

Tyre specifications: 235/55R19 101V,  
235/55R19 101H

For tyre sizes suitable for this vehicle, please contact a Forthing service station.

### Replacement of tyres and wheels

Replace with radial tyres having the same size, load scope, speed level and maximum cold tyre pressure (indicated on the tyre wall). Mixed use of radial and diagonal tyres may reduce the vehicle's

braking capacity, driving force (ground adhesive force) and steering accuracy. Using tyres of different sizes or structures will cause the ABS system to fail to work normally.

The ABS system works by comparing the speed of wheels. Therefore, when replacing tyres, be sure to use tyres with the same size as the original ones. Inconsistent tyre size and structure will affect wheel speed and may lead to uncoordinated system action. Replacing only one tyre will seriously affect the maneuverability of the vehicle. If it is necessary to replace tyres, it is recommended to replace two front tyres or rear tyres in pairs. If necessary, replace four tyres at the same time.

If the wheel needs to be replaced, make sure that the specifications of the new wheel are consistent with those of the original wheel. Before replacing the wheel, please contact a Forthing service station.

### Winter tyre

It is recommended to use winter tyres on icy and snowy roads due to the limited applicability of summer tyres in winter. When installing winter tyres, four wheels shall be installed at the same time to ensure safe driving. Only tyres of the same brand and shape can be used. When purchasing, pay attention to the tyre size, load capacity and speed grade. If you use winter tyres with a lower rated speed, do not exceed the rated speed of the tyres when driving.

### Anti-skid chain

Anti-skid chains can only be used in emergency situations or when driving through specific areas expressly

stipulated by law.

Snow anti-skid chains should be installed on at least two driving wheels at the same time. It is forbidden to install anti-skid chain on only one front or rear wheel. Do not install anti-skid chains on one side of two left wheels or two right wheels. For specific installation precautions, please follow the instructions of the anti-skid chain manufacturer. The suggestions provided in this manual are for reference only. The actual installation shall be subject to the communication result between the vehicle owner and the anti-skid chain manufacturer.

It is recommended to use anti-skid chains suitable for the tyre specifications of this vehicle. For detailed information, please contact a Forthing service station. After installing anti-skid chains, the vehicle has poor maneuverability. Drive at a low speed and avoid full load. Please read the component assembly drawing and other instructions of the anti-skid chain manufacturer carefully.

### Direct tyre pressure monitoring system

The tyre pressure monitoring system is used to dynamically monitor the tyre pressure and temperature. When the tyre pressure is abnormal, the instrument cluster will display corresponding alarm information (see "Warning light" in Chapter "Instrument Cluster" for details). When the vehicle is started, the system will carry out functional detection. At this time, it is normal that the TPMS fault warning light illuminates for a short time. Please pay attention to any abnormal air pressure loss in time. When the tyre pressure monitoring system gives an alarm, the vehicle must be checked

to ensure that it continues to operate normally. If a tyre blows out while driving, avoid severe braking and violent turning of the steering wheel, gradually reduce the vehicle speed, and call for help after safe parking.



### Caution

- If the vehicle runs on a dirt road, gravel road, mountain road or icy and snowy pavement or in SPORT mode for a long time, the alarm time of tyre pressure monitoring system may be prolonged.
- There is no need to re-match the tyre pressure sensor due to installation and removal of tyres. However, if the tyre position changes and the tyre pressure sensor position changes, it is necessary to re-match the tyre pressure. Please contact a Forthing service station.
- The tyre pressure information displayed in the stationary status is the information when the vehicle is last running. Therefore, if it is necessary to update the tyre pressure data after the tyre is deflated or inflated, it is necessary to drive the vehicle at a speed of more than 30 km/h for 1 minute before the tyre pressure information interface updates the data.



### Warning

- Different tyre pressures or excessively low tyre pressures may cause tyre function failure, tyre blowout, vehicle out of control, etc., resulting in serious casualties. Therefore, be sure to inflate all tyres to the air pressure value specified on the tyre pressure label before driving, so as to ensure the effectiveness of TPMS.
- In special cases, such as sports driving mode and snowy or spongy roads in winter, tyre under-pressure may lead to delayed identification or false alarm.

### **Hazard warning device.. 189**

Hazard warning light..... 189

Warning triangle..... 189

### **On-board tools and reflective vests..... 189**

### **Tyre Replacement..... 189**

Preparations for tyre replacement..... 189

Taking out the spare tyre 190

Jack the vehicle ..... 190

Spare tyre replacement .. 190

Fix the flat tyre ..... 191

### **Tyre repair\* ..... 191**

Usage of emergency tools for vehicle tyre repair ..... 191

### **Replace the bulb..... 194**

Bulb specifications ..... 194

Headlight calibration ..... 194

### **Replacement of Wiper Blade ..... 195**

Wiper Repair Mode..... 195

Front wiper blade replacement ..... 195

Rear wiper blade replacement ..... 195

### **Replacement of fuse ..... 196**

Positions of fuse boxes... 196

Check the fuse..... 196

Replace the fuse..... 196

Layout of Engine

Compartment Fuse Box.. 197

Layout of interior fuse box ..... 199

### **Vehicle towing..... 201**

Front towing point ..... 201

Rear towing point..... 201

Towing method ..... 201

### **Jump Start..... 202**

Operation steps ..... 202

### **Operating instructions for power battery ..... 203**

High-voltage cables ..... 203

Power battery overheating..... 203

If a vehicle collision occurs ..... 204

Emergency cut-off system for high-voltage electrical systems ..... 204

When the vehicle is scrapped ..... 204

Description of power battery cooling system..... 204

Power Battery Recycling 204

### **Long-term parking of vehicles ..... 205**

## Hazard warning device

### Hazard warning light



Press the hazard warning light switch above the A/C control panel, and the direction indicators and hazard warning indicators on the instrument cluster will start to flash to remind pedestrians and passing vehicles to avoid the vehicle.

### Warning triangle

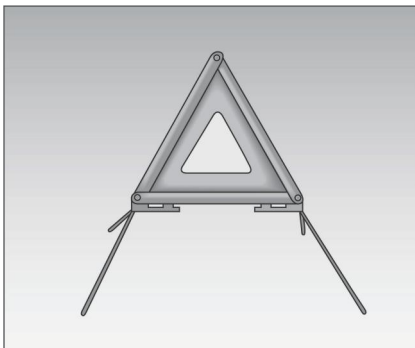

The warning triangle is placed in the storage slot under the boot lid.

In case of an accident during driving, stop the vehicle on the right side as far as possible, take out the warning triangle, turn the reflector back to the vehicle and stand 100 ~ 200 m behind the vehicle to remind the vehicle coming behind, and turn on the hazard warning light at the

same time.

## On-board tools and reflective vests



1. Warning triangle
2. Reflective vest
3. Towing hook
4. Wheel nut cover clip
5. Emergency tyre repair kit

The warning triangle, towing hook, wheel nut cover clip and emergency tyre repair kit are placed in the fitted foam under the boot lid; the reflective vest is placed in the glove box.

## Tyre Replacement

The original vehicle is not equipped with a jack. You can refer to the following operation steps when replacing tyres.

### Preparations for tyre replacement

Park the vehicle in a place where the traffic flow is little and it is convenient to replace the wheel safely. Before emergency replacement of wheels, turn on the vehicle hazard warning light and place a warning triangle at an appropriate distance to avoid traffic accidents.

Take out the on-board tools from the card-mounted foam under the boot lid.

## Emergency self-handling

### Taking out the spare tyre



Unscrew the centre bolt fixing the spare tyre, and take out the spare tyre from the spare tyre groove.

### Jack the vehicle

Before jacking the vehicle, place a stopper in front of and behind the wheel diagonally opposite to the replaced tyre, and then loosen the replaced wheel nut by half a turn with a wrench.



Place the jack at the fulcrum beside the wheel to be replaced, and then lift the vehicle.

### Warning

- It shall be used on a level and solid ground as much as possible Jack

### Warning

- It is recommended that the wheels of the vehicle be treated with anti-skid treatment, and no personnel should remain in the vehicle supported by the jack.
- No one may place any part of his body Under the vehicle supported by a jack.

### Spare tyre replacement



Take out the wheel nut cover clip from the on-board tools and use the clip to remove the wheel nut trim cover.



Remove the wheel nuts with a wheel nut wrench, and then remove the tyre. Remove all sludge from the hub surface and install the spare tyre. Tighten the wheel nuts in a crossed sequence as

shown in the figure until the wheel is close to the brake hub. Lower the vehicle to the ground and take out the jack. Tighten the wheel nuts in the same cross manner. The specified torque shall be used when tightening the wheel nuts.

### Fix the flat tyre

After replacing the spare tyre, place the replaced tyre in a suitable position and fix it.



#### Caution

- Frequently check the inflation pressure of the spare tyre to keep the inflation pressure within the specified range, so that it can be used in an emergency at any time. If the spare tyre has not been used for many years, please contact a Forthing service station to ensure that your spare tyre can still be used safely.
- The spare tyre can only be used for emergency and is not allowed to be used for a long time.
- The spare tyre is not allowed to be installed on the steering wheel (i.e. front wheel). If a tyre of steering wheel needs to be replaced, the spare tyre shall be installed on the rear wheel first, and then the removed rear wheel shall be installed on the front.

### Tyre repair\*

Your vehicle is equipped with emergency tyre repair tools, and vehicles equipped with emergency tools for vehicle tyre repair do not have spare tyres. Minor damage to the tyre tread can be repaired with a vehicle tyre repair emergency tool.

### Usage of emergency tools for vehicle tyre repair

1. If the tyre is punctured, please park the vehicle on a solid, flat and non-slippery road away from traffic flow. After parking the vehicle steadily, press the P gear button to turn on the hazard warning lights and place a warning triangle at an appropriate distance.
2. Take out the emergency tyre repair kit from the fitted foam under the boot lid, and take out the inflation pump and tyre sealant bottle.
3. Pull out the inflation pump hose and power cord, connect the inflation pump hose with the air inlet of the tyre sealant bottle, and then tighten it. Insert the tyre sealant solution bottle into the fixing groove on the inflation pump and keep it upright.

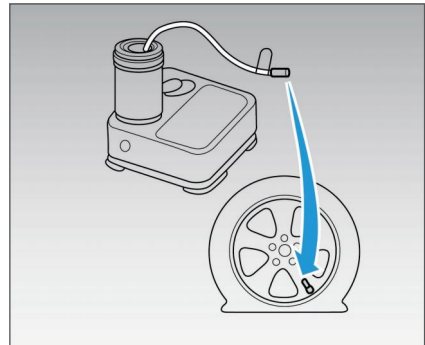

4. Unscrew the protective cap of the valve of the faulty tyre, connect the hose of the tyre sealant with the tyre valve, and tighten it.

## Emergency self-handling

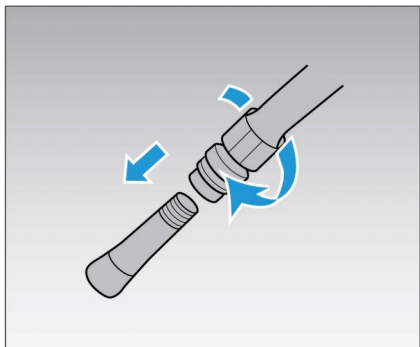

5. Start the vehicle, insert the power connector of the inflation pump into the 12V power supply, and turn on the inflation pump switch.

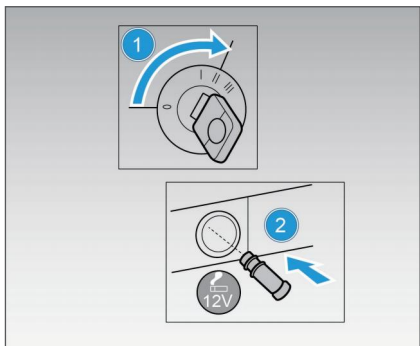

6. When the tyre pressure rises to 2.0 ~ 2.5 bar, turn off the inflation pump switch, unscrew the inflation pump hose and put the inflation pump away. If the tyre pressure does not reach 2.0 ~ 2.5 bar after more than 10 minutes of inflation, please stop repairing immediately and refer to 7.2.2.

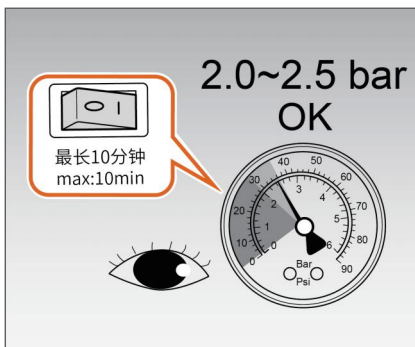

7. After tyre repair, unscrew the tyre sealant hose, disconnect the power connector, and put the emergency tools for vehicle tyre repair into the boot. After driving for the first 5 km within 1 minute, please check the tyre pressure with the inflation pump.

7.1 If the tyre pressure is still within the range of 2.0~2.5bar, you can continue to drive about 100 kilometres and go to the nearest Forthing service station for help. The speed must not exceed 80km/h.

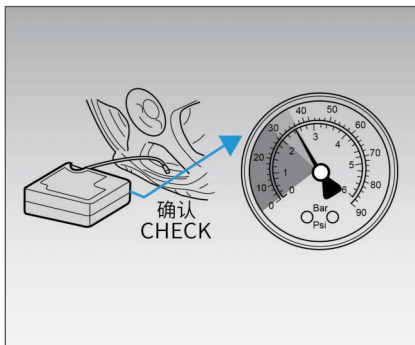

7.2 When the tyre pressure is lower than 2.0 bar, please inflate again with an inflation pump to a range of 2.0 ~ 2.5 bar. After driving for 5 km, check the tyre pressure with the inflation pump again.

7.2.1 If the tyre pressure is still within the range of 2.0~2.5bar, you can continue to drive about 100 kilometres and go to the

nearest Forthing service station for help. The speed must not exceed 80km/h.

7.2.2 When the tyre pressure is lower than 2.0 bar, please park the vehicle away from the traffic flow. Turn on the hazard warning light, place a warning triangle at an appropriate position, and contact a Forthing service station.



### Warning

- The emergency tools for vehicle tyre repair are limited to emergency repair of tyres, and are suitable for short-distance use to ensure that the vehicle can be driven to the nearest Forthing service station in case of emergency. Before operation, be sure to carefully read the operating instructions of the emergency tools for vehicle tyre repair and replace the tyre as soon as possible.
- Park the vehicle as far away from the traffic flow as possible, and turn on the hazard warning lights and place the warning triangle when necessary.
- Tyre damage and wheel damage caused by driving under low tyre pressure will significantly reduce the driving safety of the vehicle. Do not continue driving and immediately contact a Forthing service station.

### Warning

- If the tyre leakage point is large or the damaged position is on the tyre sidewall near the rim, do not use the emergency tools for vehicle tyre repair. Please contact a Forthing service station.
- Do not pull out objects (screws or nails, etc.) that may cause tyre damage during operation.
- During inflation, the temperature of the inflation pump and its hose will rise, which is normal.
- The validity period of the tyre sealant is five years. Please confirm the production date before use (the production date is printed on the tyre sealant tank).
- Do not allow tyre sealant to come into contact with skin or eyes, and store it away from children.
- Do not allow tyre sealant to come into contact with skin or eyes, and store it away from children.
- The external temperature range for normal operation of tyre sealant is  $-30^{\circ}\text{C} \sim 70^{\circ}\text{C}$ .
- The tyre sealant is a disposable item. After emergency tyre repair or expiration of the tyre sealant, please go to a Forthing service station to purchase new tyre sealant as soon as possible to ensure that the vehicle always has the tyre sealant. After successful repair with emergency tools for vehicle tyre repair, please go to a Forthing service station for help as soon as possible.

## Warning

- After repairing the tyre with tyre sealant, the vehicle speed shall not exceed 80 km/h during driving, and sudden acceleration, sudden braking and rapid turning shall be avoided.

## Replace the bulb

The replacement of bulbs usually requires the removal of certain vehicle components, so professional skills are required for relevant operations, otherwise the light cover may be damaged. If replacement is required, please contact the Forthing service station.

## Bulb specifications

Name	Specification
Low beam	LED
High beam	LED
Front position light	LED
Front direction indicator	LED
Daytime running light	LED
Rear position light	LED
Rear direction indicator	LED
Brake light	LED
High-mount brake light	LED
Reversing light	LED
Rear fog light	P21W
License plate light	LED

Name	Specification
Boot light	LED
Front interior light	LED
Rear interior light	LED

## Headlight calibration

When the new vehicle leaves the factory, the headlight has been calibrated. If you often use the boot to carry heavy objects, the headlight may need to be recalibrated. If you need to calibrate the headlights, please contact a Forthing service station.

## FAQ

Why does the headlight glass surface fog sometimes?

In general, the fog in the headlight is formed by condensation when the moisture in the light body material evaporates and encounters a low temperature. This is a normal physical phenomenon, and the fog will finally dissipate after each formation.

The method to eliminate fog is as follows: During driving, after the low beam is turned on for a period of time, the fog in the effective area irradiated in front of the headlight can be dissipated.

## Caution

- When the headlight is turned on, the surface temperature of the headlight is very high. Do not directly touch the surface of the light to avoid scalding.
- To avoid damaging the light, do not use invasive abrasive or chemical solvent to clean the light. Do not wipe or clean the light cover with sharp objects when it is dry.

## Replacement of Wiper Blade

### Wiper Repair Mode

When the Start/Stop switch is turned to "OFF" position, pull the wiper control handle upwards, and the front wiper will stop at a position close to the maximum height, which is convenient for maintenance and repair of the wiper blade. When the Start/Stop switch is turned to ON position again, the front wiper will automatically return to its original position.

### Front wiper blade replacement

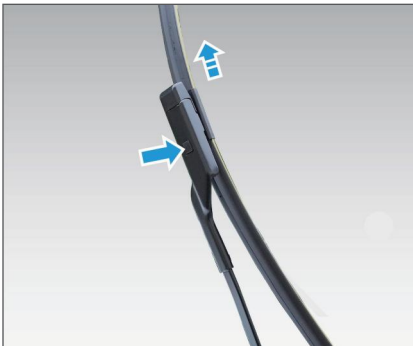

1. After the wiper repair mode is activated, pull up the wiper arm and press the wiper blade release button.
2. Pull out the wiper blade along the opening direction of the wiper rod and remove the wiper blade.
3. Replace the wiper blade with a new one, and operate in the reverse order to ensure that the wiper blade is correctly installed in place.



#### Warning

When checking, cleaning or replacing the wiper in the rain sensor area, please turn off the automatic wiper function to avoid injury to human body.

### Rear wiper blade replacement

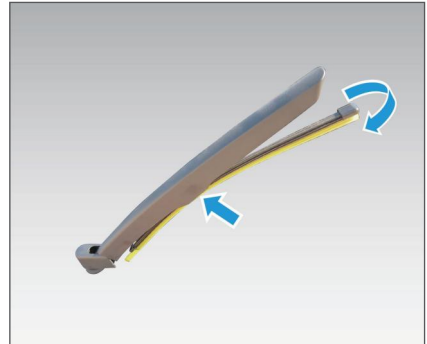

Check whether the rear wiper blade is worn or broken.

To replace the rear wiper blade, please follow the steps below:

1. Pull the rear wiper blade away from the rear windscreen.
2. Pull out the rear wiper blade from the rear wiper arm.
3. Insert a new rear wiper blade and push it in place.
4. Fold the rear wiper arm back to the rear windscreen.



#### Caution

- Please do not open the bonnet when wiper arms are pulled up. Otherwise, both the bonnet and wiper arms will be damaged.
- Make sure that the wiper blade is correctly installed in place.

## Replacement of fuse

### Positions of fuse boxes

#### Engine bay fuse box



The fuse box in the engine compartment is located at the front left side of the engine compartment. Remove the clips on the left and right sides of the fuse box, and open the box cover to check the fuse.

#### Interior fuse box



The interior fuse box is located in the lower right corner of the dashboard. Remove the cover plate to check the fuse.

### Check the fuse.

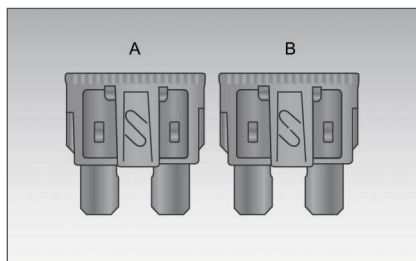

A: Normal

B: Fuse blown

The fuse protects the vehicle electrical equipment by preventing the electrical equipment in the circuit from overloading. A blown fuse indicates that the circuit it protects is faulty and stops working. If the fuse is suspected to be faulty, remove it with a fuse puller and check whether it is blown.

### Replace the fuse

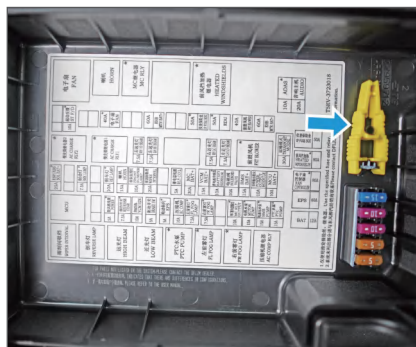

There is a fuse puller in the engine compartment fuse box. Pull the fuse straight out of the fuse box with a puller. If the fuse is not blown, there must be other causes causing the fault. Please contact a Forthing service station as soon as possible.

Identify the blown metal wire in the fuse. If the fuse is blown, replace it with a spare fuse of the same or lower amperage. If a

spare fuse with lower amperage is used and blown again, replace it with a fuse of the same rating.

If the replacement fuse with the same rating is blown again in a short time, it indicates that the vehicle may have a serious electrical fault. Please contact a Forthing service station as soon as possible.

## Layout of Engine Compartment Fuse Box

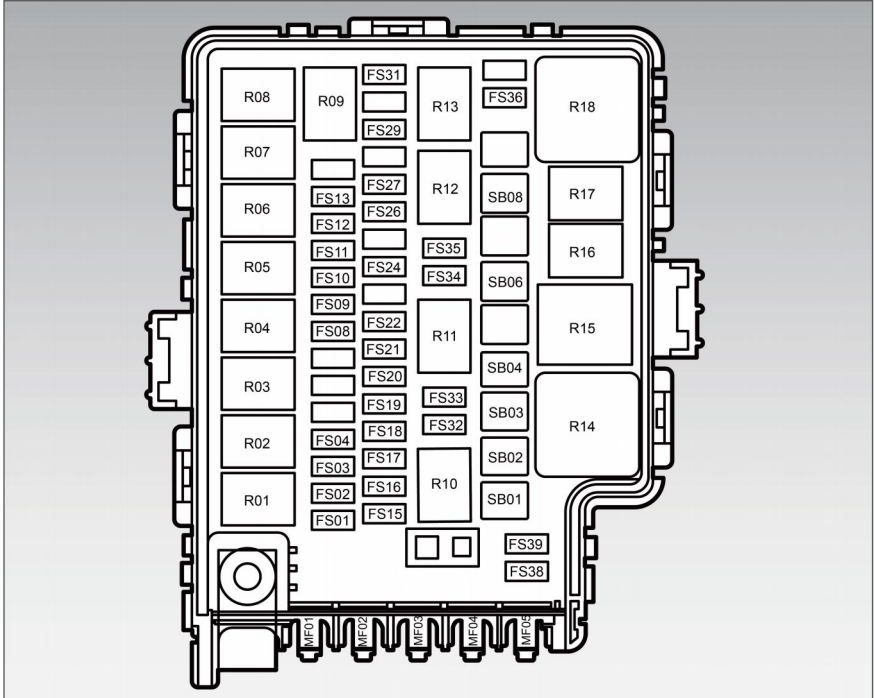

Number	Name	Rated current	Description
MF01	BAT fuse	125A	-
MF02	EPS fuse	60A	-
MF03	FAN CONTROLLER fuse	80A	-
MF04	HEATED WINDSCREEN fuse	80A	-
MF05	IP FUSE box fuse	50A	-
SB01	EHB MTR BAT+ fuse	60A	-
SB02	FRT BLOWER fuse	40A	-
SB03	EDU fuse	50A	-

## Emergency self-handling

Number	Name	Rated current	Description
SB04	IP FUSE box fuse	50A	-
SB06	EHB MTR BAT+ fuse	60A	-
SB08	FAN fuse	40A	-
FS01	PTC PUMP fuse	15A	-
FS02	BMS PUMP fuse	15A	-
FS03	MOTOR PUMP fuse	15A	-
FS04	MC RLY OUTPUT fuse	10A	-
FS08	AC COMP fuse	10A	-
FS09	EPS fuse	5A	-
FS10	BRAKE SW fuse	5A	-
FS11	VCM IGN fuse	10A	-
FS12	REVERSE GEAR fuse	7.5A	-
FS13	POWER fuse	5A	-
FS15	MCU BAT+ fuse	10A	-
FS16	POWER OUTPUT MODULE Fuse	10A	-
FS17	BMS BAT+ fuse	15A	-
FS18	SOLENOID VALVE fuse	10A	-
FS19	BATTERY SENSOR fuse	10A	-
FS20	VCM BAT+ fuse	15A	-
FS21	MC BAT + Fuse	30A	-
FS22	RLY COIL fuse	5A	-
FS24	WIPER INTERVAL fuse	20A	-
FS26	HORN fuse	15A	-
FS27	REV LAMP fuse	10A	-
FS29	BRK LAMP fuse	7.5A	-

Number	Name	Rated current	Description
FS31	ESP/ABS SOL BAT+ fuse	25A	-
FS32	LH LO BEAM fuse	7.5A	-
FS33	RH LO BEAM fuse	7.5A	-
FS34	LH HI BEAM fuse	7.5A	-
FS35	RH HI BEAM fuse	7.5A	-
FS36	ST F/D fuse	10A	-
FS38	AUDIO fuse	20A	-
FS39	ADAS fuse*	10A	-

## Layout of interior fuse box

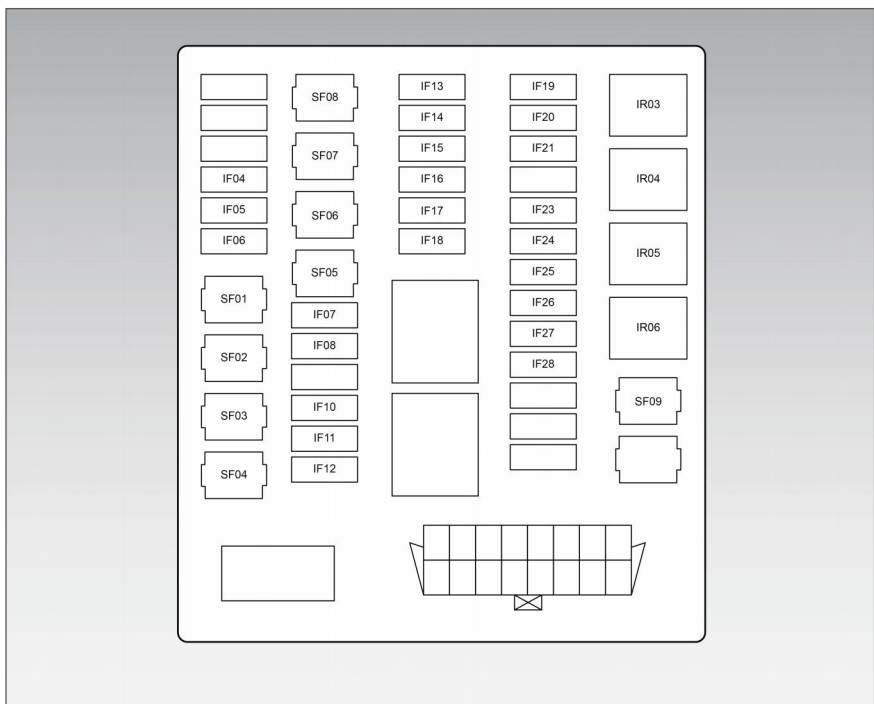

Number	Name	Rated current	Description
IF04	CHECK CONN fuse	10A	-

## Emergency self-handling

Number	Name	Rated current	Description
IF05	CHL&RHL fuses	20A	-
IF06	COMB fuse	10A	-
IF07	ROOM LAMP fuse	10A	-
IF08	SUN ROOF fuse*	20A	-
IF10	AUDIO fuse	15A	-
IF11	AUTO A/C fuse	10A	-
IF12	WASHER fuse	10A	-
IF13	AIR BAG fuse	10A	-
IF14	AUTO A/C fuse	7.5A	-
IF15	COMB fuse	7.5A	-
IF16	ENG-RM IGN1 fuse	15A	-
IF17	ROOM LAMP IGN2 Fuse	7.5A	-
IF18	IC IGN2 fuse	7.5A	-
IF19	BACK LIGHT fuse	5A	-
IF20	RF/LR POSI LAMP fuse	10A	-
IF21	LF/RR POSI LAMP fuse	10A	-
IF23	12V POWER fuse	15A	-
IF24	USB POWER fuse	10A	-
IF25	IC ACC fuse	10A	-
IF26	BLOWER FB fuse	5A	-
IF27	AVM fuse*	5A	-
IF28	AUTO A/C fuse	7.5A	-
SF01	IGN SW fuse	40A	-
SF02	DOOR LOCK fuse	20A	-
SF03	L_DCU fuse	30A	-
SF04	WIPER fuse	20A	-
SF05	EPB fuse	30A	-

Number	Name	Rated current	Description
SF06	RR DEF fuse	25A	-
SF07	ELE SEAT fuse*	25A	-
SF08	R_DCU fuse	30A	-

## Vehicle towing

### Front towing point



### Rear towing point



If the vehicle needs to be towed, contact a professional vehicle towing service department or organisation. Do not tow the vehicle only with ropes or iron chains.

### Towing method

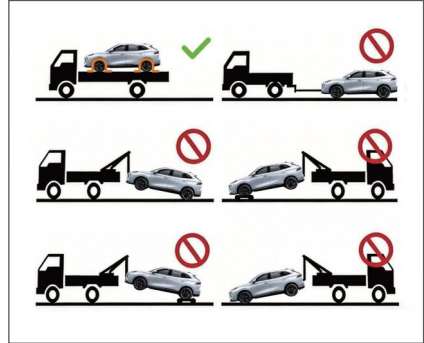

Vehicles can be loaded on trucks, which is the best way to transport vehicles. When towing the vehicle in this way, fix the front and rear wheels firmly on the trailer and place the gearshift lever at P position.

#### Caution

- Do not use the bumper as a towing point to tow the vehicle, otherwise it may cause serious damage to the bumper and body structure. When installing the towing cable, pay special attention not to damage the vehicle body by the cable.
- Your vehicle is not designed to tow other vehicles, and such attempts will cause you to lose your warranty rights.

## Emergency self-handling

### Warning

The above methods should be strictly followed. Incorrect towing will damage the vehicle.

## Jump Start

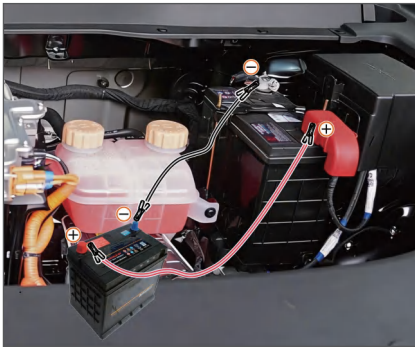

If the vehicle cannot be started due to insufficient 12V low-voltage battery, jumper cables can be used to start the vehicle with the help of the 12V low-voltage battery on other vehicles. Jumping is dangerous and should be operated with caution.

### Operation steps

1. Open the bonnet.
2. Connect the positive clamp of the jumper cable to the positive (+) terminal of the 12V low-voltage battery of the vehicle.
3. Connect the clip at the other end of the positive cable to the positive (+) terminal of the battery of the rescue vehicle.
4. Connect the negative cable clip to the negative (-) terminal of the battery of the rescue vehicle.
5. Connect the clamp at the other end of the negative cable to the negative (-) terminal of the 12V low-voltage battery of

this vehicle.

6. Start the rescue vehicle and keep it running for about 5 minutes to charge the 12V low-voltage battery of the vehicle.

7. After the vehicle is started, please remove the jumper cable in an order completely reverse to the connection, and contact a Forthing service station for vehicle maintenance as soon as possible.

### Warning

- Do not clamp the positive and negative terminals incorrectly when clamping jumper cables; otherwise, electrical equipment will be damaged.
- When jump starting, the correct operation must be carried out according to the above instructions. Otherwise, it may cause fire, explosion or vehicle damage.
- A certain distance shall be kept between the ends of two jumper cables to prevent contact, and any metal parts on the vehicle shall also be prevented from touching; otherwise, electrical equipment may be damaged.

## Operating instructions for power battery

### High-voltage cables

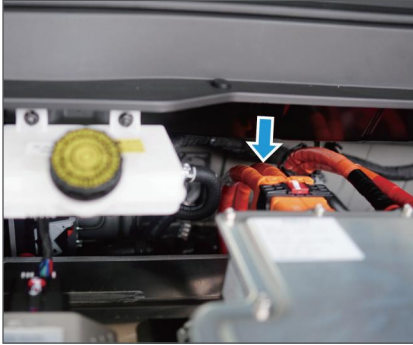

The vehicle is equipped with orange cables connected to other high-voltage components of the powertrain.

#### Danger

Do not touch or contact the orange cable and power battery electrodes; otherwise, electric shock may be caused, causing casualties.

- Do not disassemble or disassemble the power battery without permission. Otherwise, the unit or individual will bear the corresponding responsibility for environmental pollution or safety accidents caused thereby.
- Do not attempt to remove or install any high-voltage system component or disconnect any cable. Make sure that the high-voltage system is maintained or repaired only by a Forthing service station.

the vehicle immediately according to the following steps:

1. Park the vehicle safely on the side of the road, press the P gear button, pull up the EPB switch, turn off all electrical switches, and turn on the hazard warning lights.
2. If the power battery overheats due to overload, the system will continue to cool the power battery while the vehicle remains powered on (not locked) after stopping. In this case, you should wait until the powertrain fault warning light goes out before continuing driving.
3. If the vehicle is stationary and the power system overheating prompt remains after being powered on (with the vehicle not locked) for more than half an hour, check for obvious coolant leakage. For example, if the expansion tank hose is broken; all components are scorching hot at this time, so please be extremely careful. If any leakage is found, please contact a Forthing service station as soon as possible.
4. If no obvious leakage is found, the liquid level of the coolant reservoir should be checked. If the coolant level is below the lower limit (MIN) mark or there is no coolant, please contact a Forthing service station in time to add coolant so that the coolant level remains between the upper and lower limits.
5. Check whether the A/C system works normally. If not, please contact a Forthing service station as soon as possible.

### Power battery overheating

If the powertrain fault warning light on the instrument cluster illuminates and a relevant text prompt appears, inspect

## Emergency self-handling



### Warning

Do not open the coolant reservoir cap when the power battery is overheated; otherwise, coolant may spray out, causing severe burns. Be sure to wait until the power battery cools down before operating.

### If a vehicle collision occurs

#### 1. Beware of electric shock.

If the high voltage system of the vehicle is damaged by a severe collision, the high-voltage components or cables may be exposed to electric shock. If this occurs, do not touch any high-voltage system or its orange cable.

#### 2. Avoid contact with power battery electrolyte.

The power battery electrolyte is corrosive and may leak due to severe collision. Avoid skin or eye contact with electrolyte. In case of accidental contact, rinse the affected skin or eyes with plenty of water for at least 5 minutes and seek medical attention immediately.



### Danger

Do not touch the surface, bottom, water pipe and other positions of the power battery pack case where liquid appears!

#### 3. Use fire extinguishers to extinguish electrical fires.

Picture	Name	Requirements
	Fire extinguisher	Type ABC

4. In the event of a fire, use a large amount of water to extinguish the fire. Do not try to extinguish an electrical fire with a small amount of water (such as the water pipe used in the garden).

5. If the vehicle is damaged in an accident, please go to a Forthing service station for maintenance immediately.

### Emergency cut-off system for high-voltage electrical systems

In the event of a vehicle collision, depending on the severity of the collision, the emergency cut-off system may be activated. When the system is activated, the high-voltage system will be automatically cut off and the vehicle cannot run on its own power. If the high-voltage system needs to resume normal operation, please consult a Forthing service station.

### When the vehicle is scrapped

Please consult a Forthing service station when scrapping the vehicle.

### Description of power battery cooling system

The power battery is equipped with a liquid cooling system. In the event of a collision or other faults, if liquid is found at the bottom of the power battery or in the water pipes connected to the power battery, please contact a Forthing service station for repair.

### Power Battery Recycling

If the power battery of the new-energy vehicle needs to be repaired or replaced, send the vehicle to the after-sales service agency with corresponding capabilities for the repair and replacement of the power battery. Anyone who hands over used

power batteries to other organisations or individuals, and removes or disassembles power batteries without permission shall bear corresponding responsibilities if environmental pollution or safety accidents are caused thereby.



### Warning

- Scrapped cars must be handled by authorized professional equipment. If you need to handle it, please contact a Forthing service station.
- Do not dispose of or discard used power batteries at will to avoid accidental fires or serious pollution to the environment.

## Long-term parking of vehicles

If the vehicle needs to be parked for a long time, the following measures shall be taken. Appropriate measures can prevent deterioration of vehicle conditions and make it easy to restart the vehicle. If possible, please park the vehicle in a dry room and avoid long-term parking in humid environments, such as parking lots with accumulated water.

1. Long-term storage of the vehicle's power battery in an undercharged state will cause irreversible damage to the power battery. Therefore, when the vehicle is not used for a long time, please fully charge the vehicle with AC charging and then discharge it to 50%~70%, and charge it to 50%~70% with AC charging every 1~2 months. It is recommended to charge it once a month if it exceeds 3 months. AC charging mode is preferred.

2. Disconnect the wiring of 12V low-voltage battery, and insulate the cable

connector with insulating tape.

3. Block the rear wheels with obstacles to prevent backward slipping.

4. Clean the interior of the vehicle to ensure that the carpets and mats are completely dry.

5. Pad the wiper blade with a towel or cloth so that it does not come into contact with the front windscreen.

6. To reduce sticking, spray silicone lubricant on the sealing parts of all doors and the boot, and apply vehicle body wax on the paint surface where the sealing strips of doors and tailgate contact.

7. Cover the vehicle body with a breathable covering made of porous material such as cotton cloth. Non-porous materials such as plastic cloth will accumulate water vapour and damage the vehicle body surface paint.



### Caution

If the vehicle has been parked for one year or more, it may not be able to start or its manoeuvrability may become poor. In this case, please contact a Forthing service station as soon as possible.

## Vehicle Specifications

### Vehicle information .....207

- Vehicle identification information.....207
- Vehicle's factory nameplate ....  
.....207
- Drive motor information ..208

### Safety warning label.....208

- 12V low-voltage battery warning label .....208
- Radiator warning label and A/  
C refrigerant label .....208

### Microwave window .....209

### Dimensions .....210

### Weight parameters .....210

### Drive motor parameters 210

### Power battery parameters .... .....211

### Seat parameters.....211

### Main assembly parameters of chassis .....212

### Braking parameters.....212

### Performance parameters .... .....213

### Vehicle trafficability parameters .....213

### Oil specification and capacity .....213

### Energy consumption parameters .....213

### Four-wheel alignment specifications.....214

### Rim and tyre specifications .....214

## Vehicle information

### Vehicle identification information

There are several vehicle identification numbers (VINs) on your vehicle, which are located in different positions.



1.It is engraved on the body crossmember under the driver seat and can be seen by lifting the carpet gap.

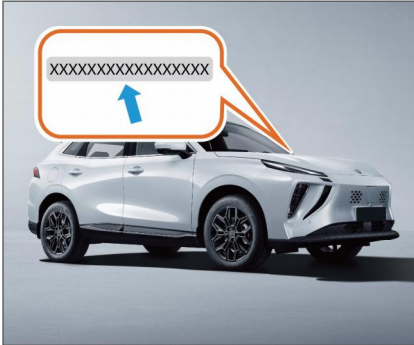

2.It is pasted on the left side of dashboard body assembly.

3.It is pasted on the inside of the glove box.

4.It is pasted on the right B-pillar inner panel.

5.It is pasted on the inner panel of the front right A-pillar.

6.It is pasted on the inner panel of bonnet.

7.It is pasted on the inner panel of boot

lid.

8.It is pasted on the drive motor assembly.

Use the OBD II scan tool to read the vehicle VIN information through the OBD diagnostic interface.



### Caution

The above VIN reading tool is not equipped with the vehicle. If you need to purchase it, please contact a Forthing service station.

### Vehicle's factory nameplate



The vehicle's factory nameplate contains the following information:

1. Country of manufacture
2. Manufacturer
3. Brand name
4. VIN
5. Vehicle model
6. Manufacturing date
7. Gross combined weight rating (GCWR)
8. Model of drive motor
9. Rated voltage/capacity of power battery system
10. Drive motor peak power
11. Seating capacity

# Vehicle Specifications

## Drive motor information

### Drive motor steel code

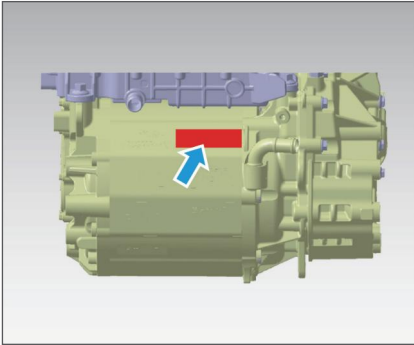

The drive motor steel code is located on the front right side of the motor housing.

### Drive motor flexible label

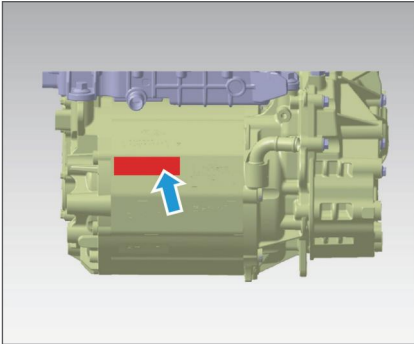

The drive motor flexible label is located on the front left side of the motor housing. The information content is consistent with the drive motor steel code.

## Safety warning label

### 12V low-voltage battery warning label



The 12V low-voltage battery warning label is affixed to the surface of the 12V low-voltage battery. The 12V low-voltage battery shall be kept away from heat sources and open flames, and ventilation shall be maintained during charging and use to prevent accidents.

### Radiator warning label and A/C refrigerant label



The radiator warning label and the A/C refrigerant label are pasted above the inner side of the bonnet. Coolant specified by Forthing shall be used. Do not mix coolants of different brands. Do not touch the radiator, as the cooling fan

may start at any time.

## Microwave window



The microwave window of the vehicle is located in the horizontal center and vertically upward position of the front windshield.

The electronic identification of the vehicle should be installed in the middle and left of the microwave window. This sign stores relevant information of the vehicle and cannot be blocked by the interior rearview mirror mounting bracket, sensor bracket, etc.



### Caution

- Please keep the front windscreen clean and dry.
- Do not paste film or metal materials on the microwave window to ensure the standard installation of vehicle electronic identification and effective reading of data.
- Do not cover, squeeze or remove the electronic identification of the vehicle! If the sign is damaged, please apply again at the sign issuing agency in time.

# Vehicle Specifications

## Dimensions

Item	Unit	LZ6460XPE0EV-500 Driving range
Vehicle length	mm	4600
Vehicle width	mm	1860
Vehicle height	mm	1680
Front wheel track	mm	1590
Rear wheel track	mm	1595
Wheelbase	mm	2715

## Weight parameters

Item	Unit	LZ6460XPE0EV-500 Driving range
Seating capacity	Person	5
Kerb mass	kg	1920
Front axle kerb mass	kg	1060
Rear axle kerb mass	kg	860
Maximum mass	kg	2535
Maximum mass of front axle	kg	1220
Maximum mass of rear axle	kg	1315

## Drive motor parameters

Item	Unit	LZ6460XPE0EV-500 Driving range
Model of drive motor	-	TZ200XSV
Type	-	Permanent magnet synchronous motor
Rated power	kW	80
Peak power	kW	150
Rated speed	rpm	5457
Maximum rotation speed	rpm	16000
Rated torque	N·m	140
Maximum torque	N·m	340
IP rating	-	IP67

## Power battery parameters

Item		LZ6460XPE0EV-500 Driving range
Power battery model		TP Li 64.4-312
Power battery type		Lithium iron phosphate battery
Battery cell information	Rated voltage (V)	3.16
	Rated capacity (Ah)	103
Power battery information	Voltage (V)	312
	Capacity (Ah)	206
	Power battery pack mass (kg)	495
	IP rating	IP67
	Number of power battery packs	1

## Seat parameters

Item	Driver seat	Front passenger seat	Rear seat
Forward and backward position adjustment	200 mm forward 30 mm backward	200 mm forward 30 mm backward	/
Upwards/downwards adjustment	Manual: 30 mm upward 15 mm downward	/	/
	Electric: 40 mm upward 20 mm downward		
Backrest angle adjustment	60° forward 30° backward	60° forward 30° backward	The backrest angle is not adjustable, but can be unlocked and laid down

## Main assembly parameters of chassis

Item		LZ6460XPE0EV-500 Driving range
Suspension system	Front suspension	MacPherson type independent suspension
	Rear suspension	Multi-link independent rear suspension
Steering system	Power steering type	Electric steering
Brake system	Structural type	"X" type double-circuit hydraulic layout
	Front brake	Disc brake
	Rear brake	Disc brake
	Free stroke of brake pedal	1mm ~ 12mm
	Brake clearance of front and rear brakes	0.1mm ~ 0.4mm

## Braking parameters

Item		LZ6460XPE0EV-500 Driving range
Front wheel brake disc	Setting value (mm)	28
	Service limit (mm)	26
Front wheel brake pad	Setting value (mm)	10
	Service limit (mm)	2
Rear wheel brake disc	Setting value (mm)	14
	Service limit (mm)	12
Rear wheel brake pad	Setting value (mm)	10.2
	Service limit (mm)	2



### Caution

To ensure that the brake system is always in optimal working condition, you should regularly go to a Forthing service station to check the wear of the brake pads and brake discs/drums.

## Performance parameters

Item	Unit	LZ6460XPE0EV-500 Driving range
Maximum speed	km/h	180
Maximum gradeability	%	>30

## Vehicle trafficability parameters

Item	Unit	LZ6460XPE0EV-500 Driving range
Approach angle (no load)	°	17
Departure angle (no load)	°	26
Ramp angle (full load)	°	15
Minimum turning diameter	m	11.8
Minimum ground clearance	mm	175

## Oil specification and capacity

Item	Specification	Filling amount
Reducer lubricating oil	Castrol BOT 384	1.3±0.05L
Electric drive coolant	OAT-35	5.74±0.8L
Power battery coolant	OAT-35	7.2±0.8L
Brake fluid	DOT4	0.7±0.1L
Windscreen washer fluid	NFC-60	2.0L
A/C refrigerant	R-134a	600±20g

## Energy consumption parameters

Item	Unit	LZ6460XPE0EV-500 Driving range
Comprehensive power consumption (WLTC condition)	kWh/100km	18.5

## Four-wheel alignment specifications

Item		LZ6460XPE0EV-500 Driving range
Front wheel toe-in	Front wheel	$0.08^{\circ} \pm 0.04^{\circ}$
	Rear wheel	$0.08^{\circ} \pm 0.08^{\circ}$
Wheel camber angle	Front wheel	$-0.3^{\circ} \pm 0.5^{\circ}$
	Rear wheel	$-0.86^{\circ} \pm 0.5^{\circ}$
Kingpin caster angle	Front wheel	$6.01^{\circ} \pm 0.5^{\circ}$
Kingpin inclination angle	Front wheel	$13.29^{\circ} \pm 0.5^{\circ}$

## Rim and tyre specifications

Item	LZ6460XPE0EV-500 Driving range
Tyre specification	235/55R19 101V, 235/55R19 101H
Rim specification	19×7J
Tyre pressure (no load)	230kPa
Tyre pressure (full load)	230kPa
Spare Tyre Specification	T155/90R17 112M
Spare Tyre Pressure	420kPa



